

LEIDINGSYSTEEM
VOOR SANITAIR EN
VERWARMING

RIIFO EUROPE

E-mail: info.eu@riifo.com

Website: www.riifo.eu

Wijzigingen voorbehouden. Alle informatie in deze publicatie is over het algemeen up-to-date op het moment van drukken. Bovendien is deze publicatie met de grootst mogelijke zorg samengesteld. Druk- of vertaalfouten kunnen we echter niet uitsluiten. Verder behouden wij ons het recht voor om producten, specificaties en andere informatie te wijzigen, of wijzigingen kunnen noodzakelijk zijn vanwege wettelijke, materiële of andere technische vereisten, die niet langer

in aanmerking konden komen voor deze publicatie. Om deze reden kunnen wij geen aansprakelijkheid aanvaarden indien deze uitsluitend gebaseerd is op de informatie in deze publicatie. Niets uit deze uitgave mag worden gekopieerd, vervoelvoudigd en/of openbaar gemaakt door middel van herdruk, fotokopie, overdracht op microfilm of welke andere reproductiemethode dan ook zonder voorafgaande toestemming van RIIFO EU.

Date Modified: April 26, 2022

INHOUD

03 OVER RIIFO

07 OPLOSSINGEN

05 INNOVATIE

09 SEGMENTEN

06 SCHAAL
06 Faciliteiten
06 Capaciteit

10 KWALITEIT

12 PROJECTREFERENTIES

85 MEERLAGENBUIS
SYSTEEM VOOR GAS

86 Buizen
87 Perskoppelingen

17 MEERLAGENBUIS
LEIDINGSYSTEEM

23 Meerlagenbuizen
25 Multiprofiel perskoppelingen
37 Steekkoppelingen
43 Knelkoppelingen
51 Verdelers
53 Adapters

91 KRANEN

55 PE-X LEIDINGSYSTEEM

56 Buizen
57 Koppelingen

94 TOOLS EN
TOEBEHOREN

58 VLOERVERWARMINGSSYSTEEM

56 Buizen
57 Verdelers
61 Toebehoren Verdelers
65 Systeemcomponenten

99 INSTALLATIE

69 PP-R SYSTEEM

70 Buizen
74 Koppelingen

99 GARANTIE



OVER RIIFO

RIIFO is een toonaangevende internationale onderneming die allesomvattende leidingoplossingen biedt die worden toegepast in de residentiële, commerciële, agrarische, industriële en infrastructurele sector. Met meer dan 8.000 medewerkers, 70 vestigingen en dochterondernemingen en 300.000 distributeurs zijn we sinds 1996 voortdurend opnieuw aan het

uitvinden en bedienen we klanten in meer dan 100 landen en regio's.

Met een geïntegreerde waardeketen, van R&D over productie tot groot-en kleinhandel, streven we ernaar om onze missie te vervullen om iedereen ideale leidingsystemen en diensten aan te bieden.

8,000

Medewerkers

300,000

Verdelers wereldwijd

100+

Aanwezig in meer dan 100 landen en regio's

70

Vestigingen en dochterondernemingen

INNOVATIE

In de overtuiging dat innovatie de sleutel is om verder te gaan dan het gewone, heeft RIIFO laboratoria van wereldklasse opgericht die worden erkend en gecertificeerd door CNAS. Meer dan 600 innovatietalenten sparen geen enkele moeite om industriële grenzen te verleggen en hebben 923

patenten behaald en daarnaast 20 technologieprijzen. En deze innovatieve passie heeft zich perfect vertaald in hoogwaardige producten en uitstekende service. We streven ernaar om voor iedereen de ideale leidingoplossing te bieden.



SCHAAL

We gebruiken sterk geautomatiseerde productielijnen met de meest rigoureuze en uitgebreide productiecontroles en beheersystemen om zo'n krachtige productie aan te kunnen.

Faciliteiten

11

Wereldwijde productiesites

5,200+

Productiemedewerkers

200

Hectare gebied totaal

4,000+

Geautomatiseerd productielijnen

Capaciteit

Productiecapaciteit

- Buizen: 3,2 miljard m/jaar
- Koppelingen: 1,3 miljard stuks/jaar

Opslagcapaciteit

- 1.735.000 m³ ≈ 61.950 TEU (20 GP-containers)



OPLOSSINGEN



Meerlagenbuis leidingsysteem

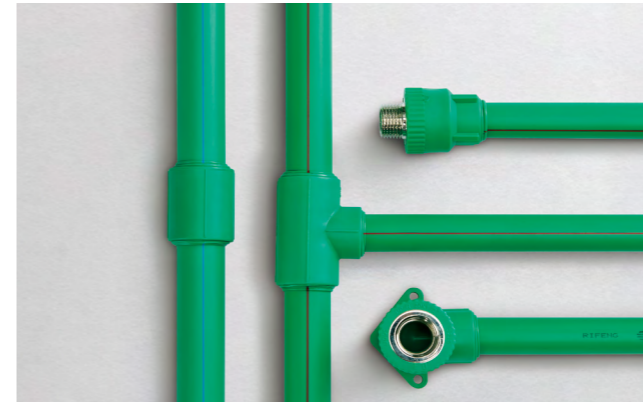

PPR leidingsysteem



Meerlagenbuis systeem voor gas



Vloerverwarmingssysteem



Meerlagenbuis systeem voor airco

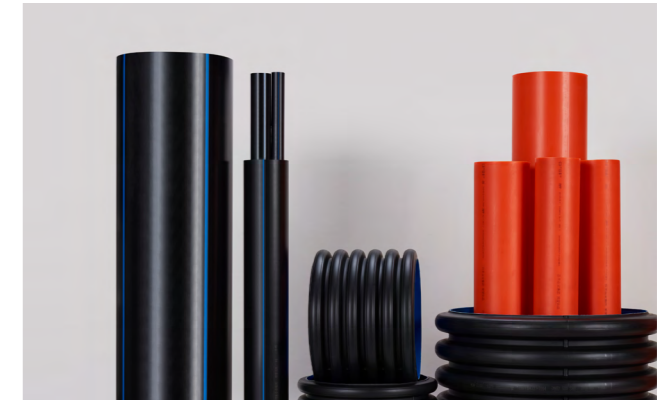

Infrastructuursystemen

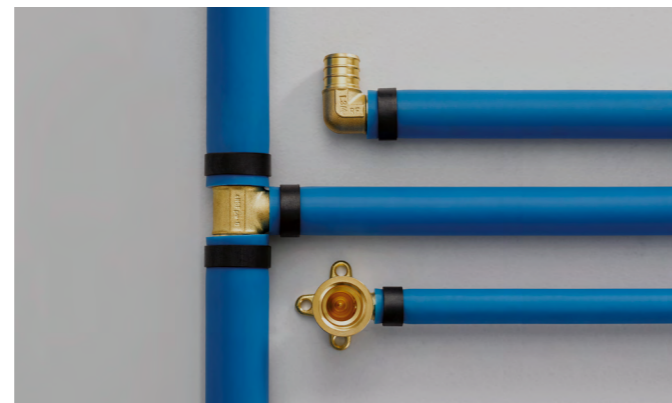

PEX leidingsysteem



PVC afvoersysteem



PVC buizen

SEGMENTEN

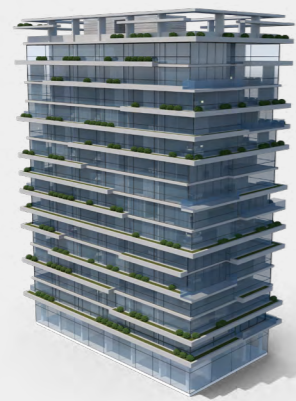

Residentieel



Commercieel



Gezondheidszorg

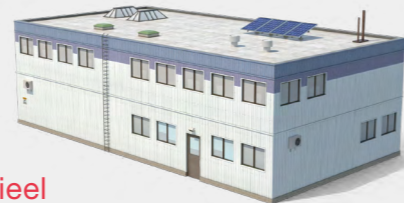

Industrieel

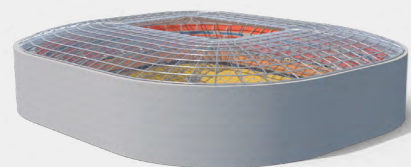

Stadion



Hotel



Familiehuizen



School

KWALITEIT

RIIFO houdt zich aan het concept van kwaliteit is prioriteit en alle RIIFO producten worden vervaardigd onder strenge kwaliteitscontroles en met een Excelsior productieapparaat. Tot nu toe heeft RIIFO meer dan 50 certificaten behaald, zoals NSF, DVGW, AENOR, WRAS Watermark, enz. Deze wereldwijde certificaten onderstrepen onze technische en kwalitatieve knowhow. Bovendien kunnen we u 25 jaar systeemgarantie bieden, ondersteund door een internationale verzekeringsmaatschappij.

Milieu en kwaliteit Management systemen



MANAGEMENT SYSTEM
ISO 9001:2015



OHSM 45001



ISO 14001



reddot



EPD®

Onderscheidingen

CERTIFICATEN



NEDERLAND



USA



DUITSLAND



FRANKRIJK



FRANKRIJK



FRANKRIJK



SPANJE



VK



FINLAND



EU



INDIA



AUSTRALIË

PROJECTREFERENTIES



Utrecht, Nederland

Project: Domkerk Domtoren
 Type: Openbare gebouwen
 Jaar: 2008
 Product: meerlagenbuis leidingsysteem



Tallinn, Estland

Project: MAXIMA Lokistisch Centrum
 Type: Commercieel
 Jaar: 2019
 Product: meerlagenbuis leidingsysteem

PROJECTREFERENTIES

Malmö, Sweden

Project: HSB Turning Torso
 Type: Residentieel
 Jaar: 2005
 Product: meerlagenbuis systeem



Pärnu, Estland

Project: Hedon Spa & Hotel
 Type: Hotels
 Jaar: 2014
 Product: meerlagenbuis leidingsysteem

Lund, Sweden

Project: Max-Lab
 Type: Wetenschappelijk
 Year: 2016
 Product: meerlagenbuis systeem

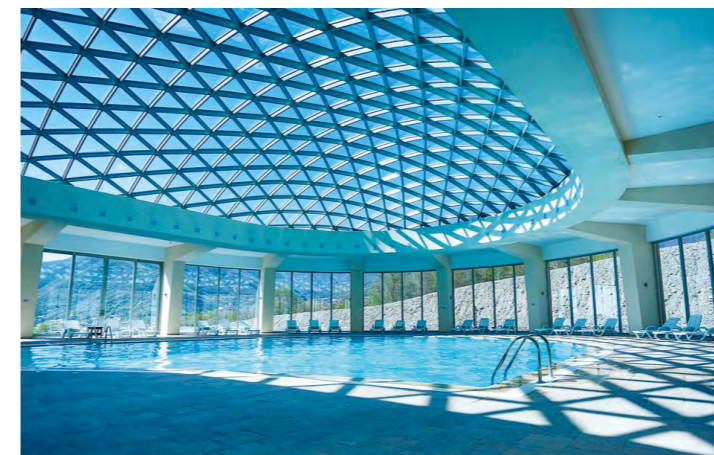

Sheki, Azerbeidzjan

Project: Marxal Resort & Spa
 Type: Hotels
 Jaar: 2016
 Product: meerlagenbuis leidingsysteem

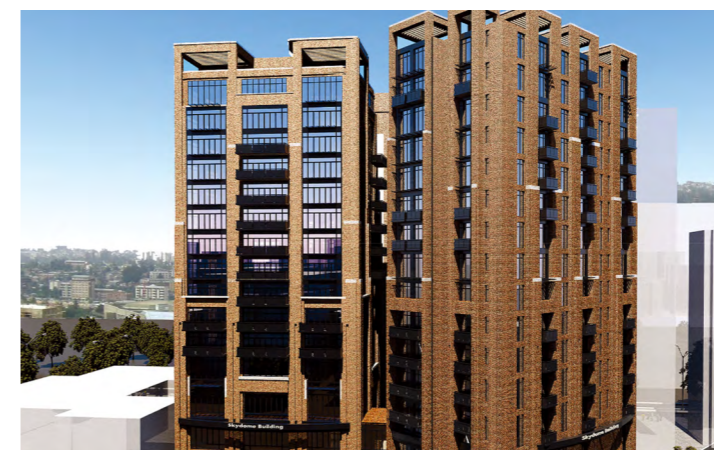

Atlas, Ethiopië

Project: Dodi Uitbreidingsstoren
 Type: Residentieel
 Jaar: 2017
 Product: meerlagenbuis sanitair Systeem en PVC afvoerbuizen

PROJECTREFERENTIES

Durban, Zuid-Afrika

Project: Parkplein
 Type: Commercieel
 Jaar: 2018
 Product: meerlagenbuis leidingsysteem

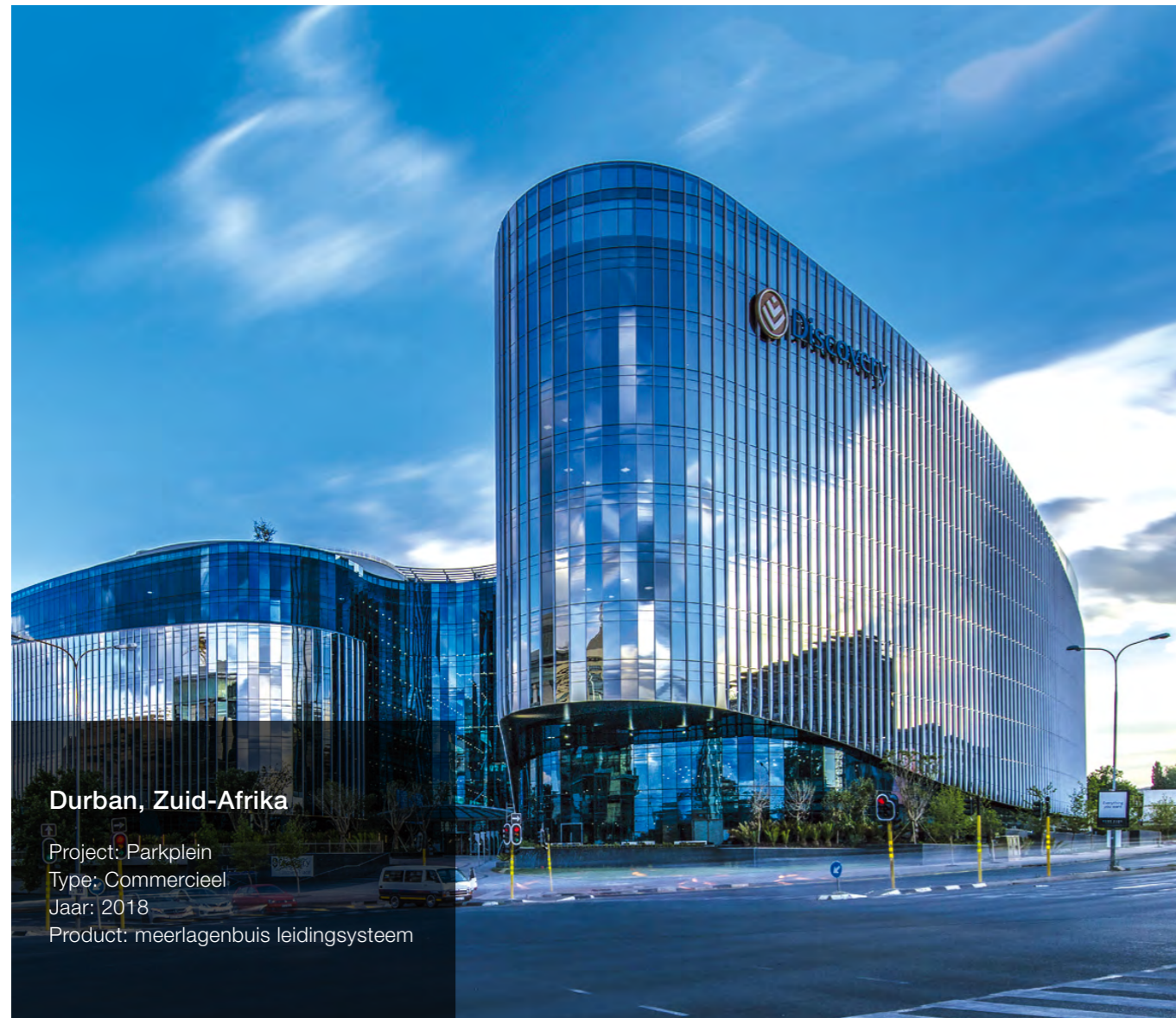

Durban, Zuid-Afrika

Project: Parkplein
 Type: Commercieel
 Jaar: 2018
 Product: meerlagenbuis leidingsysteem



Bakoe, Azerbeidzjan

Project: Nationaal Kankerziekenhuis
 Type: Gezondheid
 Jaar: 2009
 Product: meerlagenbuis leidingsysteem



Kazachse regio, Azerbeidzjan

Project: Olympisch sportcomplex Gazakh
 Type: Sport
 Jaar: 2007
 Product: meerlagenbuis leidingsysteem



Monterrey, Mexico

Project: Torre Kima
 Type: Hotels
 Jaar: 2017
 Product: meerlagenbuis systeem

Meerlagenbuis leidingsysteem



Meerlagenbuizen

Samenstelling

De RIIFO meerlagenbuis verenigt de voordelen van kunststof en metalen buizen. De binnen- en buitenlagen van polyethyleen zorgen voor flexibiliteit en lichtheid. De gladheid van de binnenste polyethyleen laag vermindert de overdracht van stromingsgeluid en voorkomt corrosie. De in lengterichting gelaste aluminiumlaag zorgt voor de stabiliteit van de buis en voorkomt het binnendringen van zuurstof. De aluminiumlaag is ook cruciaal voor de sterkte en de minimale thermische uitzetting van de buis. Aangezien de verbinding tussen de polyethyleen lagen en de aluminium laag permanent is, wordt de lineaire uitzetting van de buis bepaald door de uitzettingsfactor van aluminium die ongeveer overeenkomt met die van een metalen buis. De RIIFO meerlagenbuis biedt een hoge mate van flexibiliteit en duurzaamheid, gecombineerd met een hoge druk- en temperatuurbestendigheid. De RIIFO meerlagenbuizen voldoen aan de hoogste eisen. Alle leidingen zijn voedselveilig en volledig vrij van fysiologische risico's. Om veilige drinkwaterinstallaties

te garanderen, worden de leidingen geleverd met eindkappen ter bescherming tegen vervuiling tijdens transport, opslag of op de werf. De leidingen zijn 100% ondoordringbaar voor zuurstof, wat vooral belangrijk is voor verwarmingsinstallaties. De RIIFO meerlagenbuizen kunnen op rol of als rechte lengte worden geleverd. De RIIFO PEX/AL/PEX buis bestaat uit een in de lengte gelaste aluminium buis, waarop een binnen- en buiten laag van vernet polyethyleen (PEX) is aangebracht.

'Crosslinked' of 'vernet' betekent samengebonden of verbonden. Polyethyleen bestaat uit polymeerketens en verknoping is het proces waarbij bindingen worden gevormd om deze polymeerketens samen te voegen. RIIFO past de silaan vernettingstechnologie toe om de polymeerketens te verbinden. Op deze manier verkrijgt de polyethyleen superieure mechanische kwaliteiten en een verhoogde temperatuur- en drukweerstand.

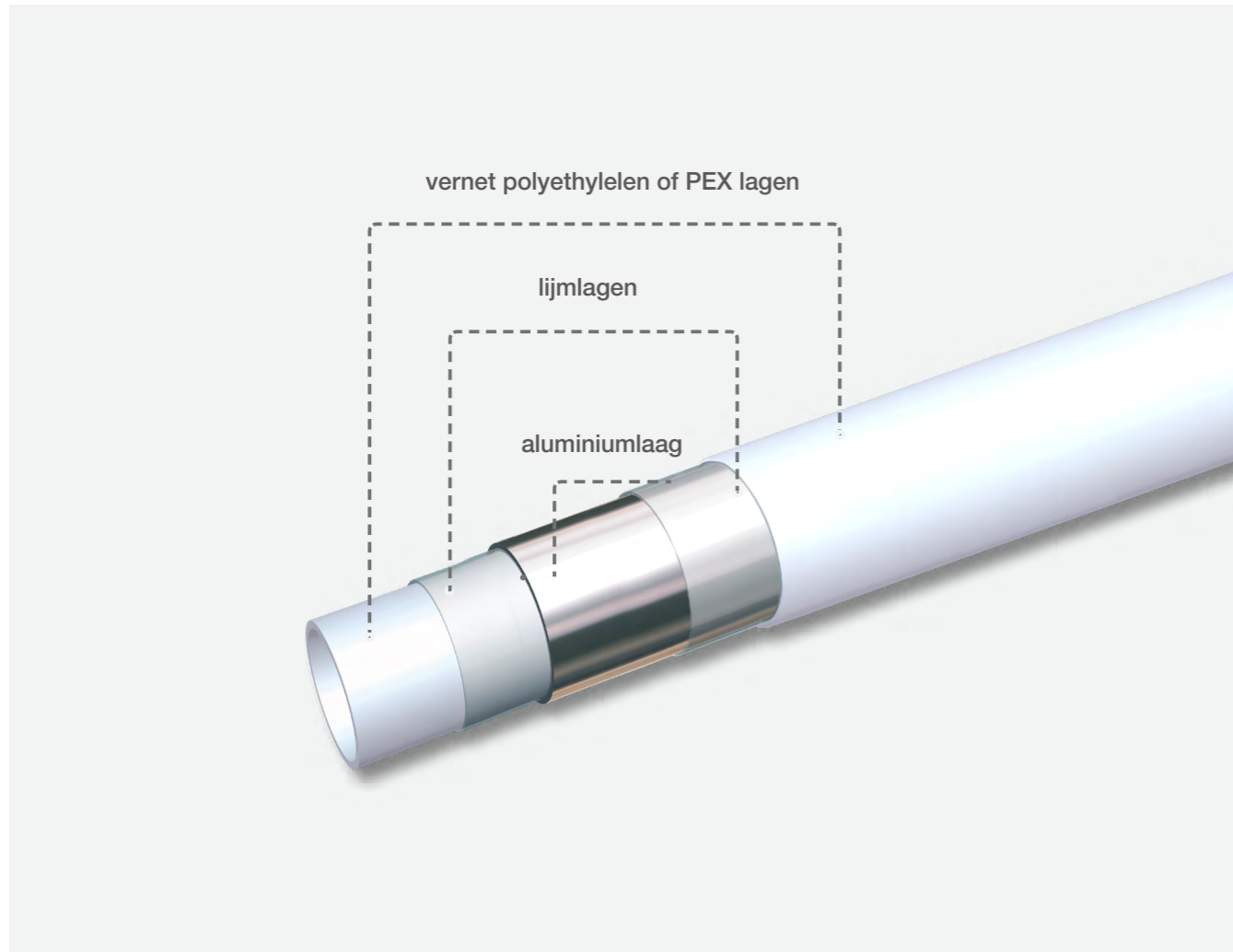

Technische data

Nominale afmetingen		12x1.5	14x2.0	16x2.0	18x2.0	20x2.0	25x2.5	26*3.0	32x3.0	40x4.0	50x4.5	63x6.0	75x7.5
Buitendiameter (mm)		12	14	16	18	20	25	26	32	40	50	63	75
Tolerantie van buitendiameter (mm)	Min	12	14	16	18	20	25.2	26	32	40	50	60.6	70.7
	Max	12.25	14.2	16.2	18.2	20.2	25.2	26.2	32.2	40.4	50.5	63	75
Binnendiameter (mm)		9	10	12	14	16	20	20	26	32	41	51	60
Tolerantie van binnendiameter (mm)	Min	8.6	9.9	11.9	13.9	15.9	19.9		25.9	30.9	39.4	49.3	57.7
	Max	8.85	10.2	12.2	14.2	16.2	20.2		26.2	31.9	40.8	50.8	59.7
Buisdikte (mm)		1.7	2	2	2	2	2.5	3	3	4	4.5	6	7.5
Tolerantie van buisdikte (mm)	Min	1.7	2	2	2	2	2.4	2.9	2.9	4	4.5	6	7.5
	Max	2	2.25	2.25	2.25	2.25	2.7	3.2	3.2	4.6	5.2	6.8	8.5
Ruwheid (mm)		0.0007											
Dichtheid (g/cm3)		0.926-0.959											
Elasticiteitsmodulus (MPa)		7200											
Thermische geleidbaarheid (w/mK)		0.45											
Coëfficiënt van thermische uitzetting (mm/mK)		0.025											
Maximalewerktemperatuur		95											
Maximale werkdruk		10bar											

Voordelen



Bestand tegen hoge druk en temperatuur. 10 bar / 95°C.



Zeer flexibel, maar toch vormstabiel



Lichtgewicht en eenvoudig te installeren.



Lage thermische lineaire uitzetting



Ondoordringbaar voor zuurstof en licht



Corrosiebestendig



Gering drukverlies door gladde binnenlaag



Hygiënisch

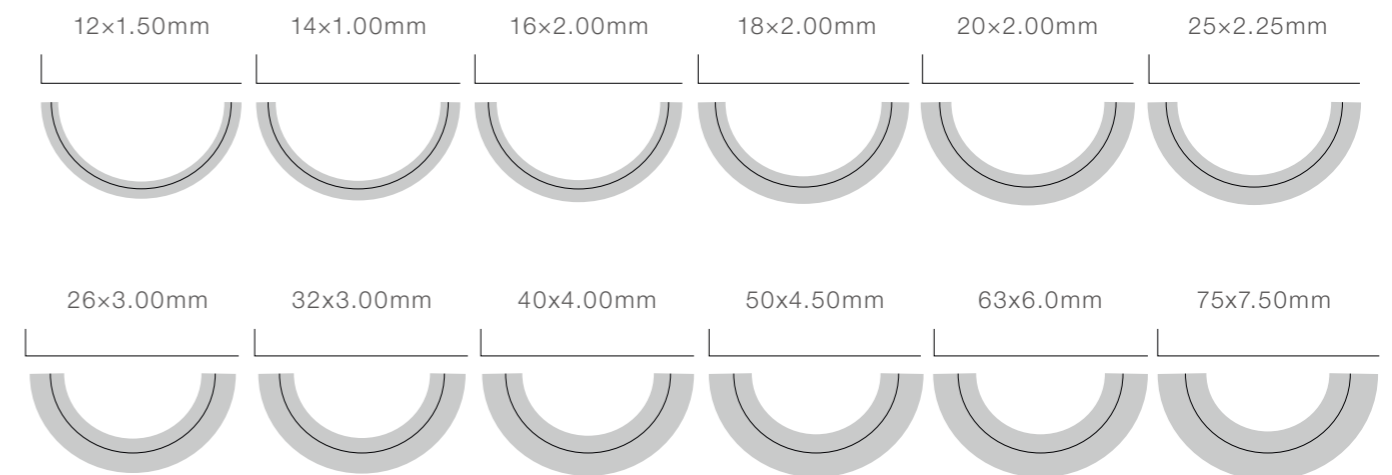

Toepassingen

De RIIFO meerlagenbuizen kunnen voor verschillende toepassingen worden gebruikt. Belangrijke toepassingen zijn onder meer sanitair- en verwarmingssystemen voor residentiële, commerciële of industriële gebouwen:



Drinkwater:

Als leiding voor warm en koud waterdistributie van elke drinkwaterkwaliteit.



Verwarming:

Als leiding voor hoge temperatuur verwarmingssystemen zoals radiatoren binnen de voorgeschreven belastingswaarden. Systemscheiding is vereist voor specifieke systemen zoals zonne-energie en stadsverwarming.



Stralingssystemen voor verwarming en koeling:

Als leiding voor lage temperatuur verwarmings- en koelsystemen.



Perslucht:

Als persluchtleiding in systemen met voorafgaande oliefilter (olievrij).



Regenwater:

Als regenwaterleidingsysteem in gebouwen en separaat van de drinkwaterinstallatie. De pH-waarde van het water moet hoger zijn dan 6.

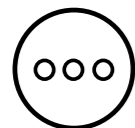

Andere applicaties:

De buis kan voor vele andere toepassingen en met andere media worden gebruikt. Neem contact met ons op voor meer informatie.

Indeling toepassingsgebieden

De prestatievereisten voor meerlagenbuis leidingsystemen conform EN ISO 21003 zijn gespecificeerd voor vier verschillende toepassingsklassen.

De keuze van de toepasselijke klasse volgens de tabel zal voor elke toepassing door de betrokken partijen worden overeengekomen. Elke toepassingsklasse moet worden gecombineerd met een ontwerpdruk, PD, van 4 bar, 6 bar, 8 bar of 10 bar, afhankelijk van de toepassing (1 bar = 0,1 MPa).

Toepassingsklasse:	Ontwerptemperatuur T_D °C	Tijd bij T_D	T_{max}	Tijd bij T_{max}	T_{mal}	Tijd bij T_{mal}	Typisch toepassingsgebied
1a	60	49	80	1	95	100	Warmwatervoorziening (60°C)
2a	70	49	80	1	95	100	Warmwatervoorziening (70°C)
4b	20/40/60 plus cumulatief	2,5	70	2,5	100	100	Vloerverwarming en lage temperatuur radiatoren
	40 plus cumulatief	20					
	60	25					
5b	20 plus cumulatief	14	90	1	100	100	Hoge temperatuur radiatoren
	60 plus cumulatief	20					
	80	10					

A. Een land kan kiezen voor klasse 1 of klasse 2 in overeenstemming met de nationale regelgeving.

B. Als er voor elke klasse meer dan één ontwerptemperatuur voor tijd en bijbehorende temperatuur voorkomt, moeten deze worden samengevoegd. "Plus cumulatief" in de tabel impliceert een temperatuurprofiel van de genoemde temperatuur in de tijd (bijv. het ontwerptemperatuurprofiel voor 50 jaar voor klasse 5 is 20 °C voor 14 jaar gevolgd door 60 °C voor 25 jaar, 80 °C voor 10 jaar, 90 °C gedurende 1 jaar en 100 °C gedurende 100 uur).
OPMERKING - Voor waarden van TD, Tmax en Tmal die hoger zijn dan die in de tabel, is deze internationale norm niet van toepassing.



PE-Xb/AL/PE-Xb MEERLAGENBUIZEN



STANGEN



Artikelnummer	Specificaties	Verpakking (m)
1100046875	16 x 2 - 5m	125
1100046876	20 x 2 - 5m	100
1100046877	26 x 3 - 5m	45
1100046878	32 x 3 - 5m	30
1100046862	40 x 4 - 5m	25
1100046863	50 x 4,5 - 5m	15
1100046864	63 x 6 - 5m	15
1100046865	75 x 7,5 - 5m	15

ROLLEN



Artikelnummer	Specification	Rol (m)
1100046874	16 x 2	100
1100046870	16 x 2	200
1100046991	16 x 2	500
1100046871	20 x 2	100
1100046872	26 x 3	50
1100046873	32 x 3	50

VOORGEÏSOLEERDE ROLLEN



Artikelnummer	Specification	Rol (m)
1100046962	16 x 2 - 6mm - RED	50
1100046963	16 x 2 - 6mm - BLUE	50
1100046964	20 x 2 - 6 mm - RED	50
1100046965	20 x 2 - 6 mm - BLUE	50
1100046948	26 x 3 - 9 mm - RED	50
1100046949	26 x 3 - 9 mm - BLUE	50
1100046950	32 x 3 - 9 mm -RED	25

ROLLEN MET MANTELBUIS



Artikelnummer	Specification	Rol (m)
1100046952	16 x 2 - RED	50
1100046954	16 x 2 - RED	100
1100046953	16 x 2 - BLUE	50
1100046955	16 x 2 - BLUE	100
1100046956	20 x 2 - RED	50
1100046957	20 x 2 - BLUE	50
1100046958	26 x 3 - RED	50
1100046959	26 x 3 - BLUE	50
1100046960	32 x 3 -RED	50
1100046961	32 x 3 -BLUE	50

MULTIPROFIEL PERSKOPPELINGEN

SAMENSTELLING

Samenstelling



Voordelen

M U – TH – H – RFz persprofielen



Betrouwbaar en makkelijk te installeren

Niet geperst, niet dicht – detectie (LBP)



Drie O-ringen voor een perfecte afdichting

Voor meerlagenbuizen en PE-X/PERT buizen: diameters 16 tot 75 mm

Doorverbinder



Artikelnummer	Specificaties	Zak (pcs)	Doos (pcs)	Karton (pcs)
1100046393	16x16	10	30	240
1100046394	20x20	5	-	200
1100046405	26x26	5	-	120
1100046406	32x32	5	-	100
1100045768	40x40	1	-	48
1100045769	50x50	1	-	33
1100045770	63x63	1	-	15
1100045771	75x75	1	-	10

Reductie



Artikelnummer	Specificaties	Zak (pcs)	Doos (pcs)	Karton (pcs)
1100046415	20x16	10	30	240
1100047050	26x16	5	15	120
1100045755	26x20	5	15	120
1100045756	32x16	5	-	120
1100046416	32x20	5	10	80
1100045758	32x26	4	8	64
1100045761	50x32	1	-	24
1100045762	50x40	1	-	24
1100045763	63x40	1	-	14
1100045764	63x50	1	-	14
1100045767	75x40	1	-	8
1100045765	75x50	1	-	8
1100045766	75x63	1	-	8

Puntstuk buitendraad



Artikelnummer	Specificaties	Zak (pcs)	Doos (pcs)	Karton (pcs)
1100046432	16x3/8M	10	40	320
1100046433	16x1/2M	5	35	280
1100046434	16x3/4M	7	28	224
1100046435	20x1/2M	10	-	250
1100046436	20x3/4M	12	24	192
1100046437	20x1M	1	20	160
1100045805	26x3/4M	5	15	120
1100045806	26x1M	5	15	120
1100047058	32x1M	6	-	108
1100045808	32x1 1/4M	6	-	72
1100047059	40x1M	1	-	60
1100045812	40x1 1/4M	1	-	60
1100045809	40x1 1/2M	1	-	32
1100045813	50x1 1/2M	1	-	40
1100045810	50x2M	1	-	20
1100045811	63x1 1/2M	1	-	20
1100045814	63x2M	1	-	20
1100045815	75x2 1/2M	1	-	14

Puntstuk buitendraad, cilindrische draad (G)



Artikelnummer	Specificaties	Zak (pcs)	Doos (pcs)	Karton (pcs)
1100052146	16xG3/8M	1	38	304
1100052147	16xG1/2M	1	38	304
1100052148	20xG1/2M	1	36	288
1100052149	20xG3/4M	1	36	288
1100052150	26xG3/4M	1	15	120
1100052151	26xG1M	1	15	120

Puntstuk binnendraad



Artikelnummer	Specificaties	Zak (pcs)	Doos (pcs)	Karton (pcs)
1100046424	16x1/2F	5	35	280
1100046425	16x3/4F	5	-	240
1100046426	20x1/2F	10	30	240
1100046427	20x3/4F	10	20	160
1100046428	20x1F	5	15	120
1100045798	26x3/4F	5	15	120
1100045799	26x1F	6	12	96
1100046431	32x1F	5	10	80
1100045807	32x1 1/4F	1	-	84
1100045800	40x1 1/4F	1	-	52
1100045804	40x1 1/2F	1	-	32
1100045801	50x1 1/2F	1	-	40
1100045802	63x2F	1	-	20
1100045803	75x2 1/2F	1	-	12

Puntstuk binnendraad, met wartel en vlakke dichting



Artikelnummer	Specificaties	Zak (pcs)	Doos (pcs)	Karton (pcs)
1100045783	16x3/8F	5	40	320
1100045784	16x1/2F	5	35	280
1100045785	16x3/4F	5	-	240
1100045786	20x1/2F	5	30	240
1100045787	20x3/4F	5	20	160
1100045788	26x3/4F	5	15	120
1100045789	26x1F	5	-	120
1100045790	32x1F	6	12	96
1100045791	32x1 1/4F	1	8	64
1100045793	40x1 1/4F	1	-	56
1100045792	40x1 1/2F	1	-	48
1100045794	50x1 1/2F	1	-	32
1100045797	50x2F	1	-	8
1100045795	63x2F	1	-	8
1100045796	75x2 1/2F	1	-	4

Persfitting adapter naar Euroconus



Artikelnummer	Specificaties	Zak (pcs)	Doos (pcs)	Karton (pcs)
1100047344	16x3/4F EK	4	-	220
1100047345	20x3/4F EK	4	-	220

Persfitting adapter naar koper knel



Artikelnummer	Specificaties	Zak (pcs)	Doos (pcs)	Karton (pcs)
1100045780	16x15CU	5	-	300
1100045781	20x22CU	5	15	120
1100045782	26x22CU	5	15	120

Persfitting adapter naar koper pers



Artikelnummer	Specificaties	Zak (pcs)	Doos (pcs)	Karton (pcs)
1100052138	16x10Cu	1	40	320
1100052139	16x12Cu	1	40	320
1100052140	16x15Cu	1	40	320
1100052141	20x18Cu	1	24	192
1100052142	20x22Cu	1	12	96
1100052143	26x22Cu	1	12	96
1100052144	26x28Cu	1	10	80
1100052145	32x28Cu	1	10	80

Stop

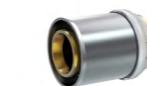

Artikelnummer	Specificaties	Zak (pcs)	Doos (pcs)	Karton (pcs)
1100045772	16	25	75	600
1100045773	20	10	40	320
1100045774	26	5	25	200
1100045775	32	8	16	128
1100045776	40	1	-	80
1100045777	50	1	-	60
1100045778	63	1	-	32
1100045779	75	1	-	16

T stuk



Artikelnummer	Specificaties	Zak (pcs)	Doos (pcs)	Karton (pcs)
1100046412	16x16x16	5	-	120
1100046413	20x20x20	5	-	100
1100045902	26x26x26	4	-	48
1100046414	32x32x32	4	-	40
1100045903	40x40x40	1	-	24
1100045904	50x50x50	1	-	18
1100045905	63x63x63	1	-	6
1100045906	75x75x75	1	-	3

T reductie



Artikelnummer	Specificaties	Zak (pcs)	Doos (pcs)	Karton (pcs)
1100045876	16x20x16	5	15	120
1100046417	20x16x16	5	-	120
1100046418	20x16x20	5	-	120
1100046419	20x20x16	5	-	100
1100045880	20x26x20	4	-	64
1100045881	26x16x16	5	-	80
1100045882	26x16x20	4	8	64
1100045883	26x16x26	4	-	64
1100047051	26x20x16	4	-	72
1100045884	26x20x20	4	8	64
1100045885	26x20x26	4	-	64
1100047052	26x26x16	4	-	64
1100047053	26x26x20	4	-	64
1100047054	26x32x26	5	-	40
1100047055	32x16x32	4	-	48
1100046421	32x20x32	5	-	40
1100045887	32x26x26	4	-	40
1100045888	32x26x32	4	-	40
1100047056	40x16x40	1	-	36
1100045889	40x20x40	1	-	28
1100045890	40x26x40	1	-	24
1100045892	40x32x40	1	-	20
1100045891	40x32x32	1	-	24
1100047057	50x20x50	1	-	20
1100045893	50x26x50	1	-	16
1100045894	50x32x50	1	-	16
1100045895	50x40x50	1	-	16
1100045896	63x26x63	1	-	4
1100045897	63x32x63	1	-	8
1100045898	63x40x63	1	-	8
1100045899	63x50x63	1	-	8
1100045900	75x40x75	1	-	3
1100045901	75x50x75	1	-	3
1100045879	75x63x75	1	-	4

T buitendraad



Artikelnummer	Specificaties	Zak (pcs)	Doos (pcs)	Karton (pcs)
1100045855	16x1/2Mx16	5	15	120
1100045856	20x1/2Mx20	5	10	80
1100047060	20x3/4Mx20	4	-	80
1100047061	26x1/2Mx26	4	-	64
1100045857	26x3/4Mx26	4	-	64
1100047062	26x1Mx26	1	-	56
1100045842	32x3/4Mx32	5	-	40
1100045858	32x1Mx32	1	4	32
1100045854	50x1 1/2Mx50	1	-	15

T binnendraad



Artikelnummer	Specificaties	Zak (pcs)	Doos (pcs)	Karton (pcs)
1100046449	16x1/2Fx16	5	-	120
1100046450	20x1/2Fx20	5	-	120
1100046451	20x3/4Fx20	5	-	80
1100045874	26x1/2Fx26	5	-	65
1100045875	26x3/4Fx26	4	-	64
1100046452	32x1/2Fx32	5	-	40
1100046453	32x3/4Fx32	4	-	64
1100046454	32x1Fx32	4	-	36
1100045862	40x1/2Fx40	1	-	24
1100045859	40x3/4Fx40	1	-	25
1100045863	40x1Fx40	1	-	24
1100045864	40x1 1/4Fx40	1	-	24
1100045865	50x1/2Fx50	1	-	16
1100045866	50x3/4Fx50	1	-	16
1100045860	50x1Fx50	1	-	22
1100045867	50x1 1/2Fx50	1	-	16
1100045868	63x1/2Fx63	1	-	6
1100045869	63x3/4Fx63	1	-	6
1100045870	63x1Fx63	1	-	6
1100045861	63x2Fx63	1	-	8
1100045871	75x1Fx75	1	-	4
1100045872	75x2Fx75	1	-	3
1100045873	75x2 1/2Fx75	1	-	3

Bocht 90°



Artikelnummer	Specificaties	Zak (pcs)	Doos (pcs)	Karton (pcs)
1100046407	16x16	5	25	200
1100046408	20x20	5	-	150
1100047049	26x26	5	-	80
1100046409	32x32	4	-	40
1100045830	40x40	1	-	36
1100045832	50x50	1	-	24
1100045834	63x63	1	-	10
1100045836	75x75	1	-	6

Bocht buitendraad 90°



Artikelnummer	Specificaties	Zak (pcs)	Doos (pcs)	Karton (pcs)
1100045816	16x3/8M	5	25	200
1100046445	16x1/2M	5	25	200
1100046446	20x1/2M	5	-	160
1100046447	20x3/4M	5	15	120
1100045817	26x3/4M	5	10	80
1100045818	26x1M	5	-	80
1100046448	32x1M	4	-	72
1100045819	40x1 1/4M	1	-	30
1100045820	50x1 1/2M	1	-	24
1100045821	63x2M	1	-	8

Bocht buitendraad 90°



Artikelnummer	Specificaties	Zak (pcs)	Doos (pcs)	Karton (pcs)
1100052153	16xG1/2M	1	25	200
1100052152	20xG3/4M	1	15	120
1100052154	26xG1M	1	8	64

Bocht binnendraad 90°



Artikelnummer	Specificaties	Zak (pcs)	Doos (pcs)	Karton (pcs)
1100046438	16x1/2F	5	-	200
1100046439	20x1/2F	5	-	200
1100046440	20x3/4F	5	15	120
1100045828	26x3/4F	6	-	120
1100045829	26x1F	6	-	96
1100046441	32x1F	4	-	64
1100045824	40x1 1/4F	1	-	24
1100045825	40x1 1/2F	1	-	25
1100045826	50x1 1/2F	1	-	30
1100045827	63x2F	1	-	8

Bocht binnendraad 90°, met wartel en vlakke dichting



Artikelnummer	Specificaties	Zak (pcs)	Doos (pcs)	Karton (pcs)
1100045838	16x3/4F	5	15	120
1100047043	20x3/4F	1	10	80
1100045839	26x3/4F	5	10	80

Bocht 45°



Artikelnummer	Specificaties	Zak (pcs)	Doos (pcs)	Karton (pcs)
1100046410	26x26	5	-	80
1100046411	32x32	5	-	60
1100045831	40x40	1	-	20
1100045833	50x50	1	-	15
1100045835	63x63	1	-	10
1100045837	75x75	1	-	6

Persfitting adapter naar koper knel



Artikelnummer	Specificaties	Zak (pcs)	Doos (pcs)	Karton (pcs)
1100045780	16x15Cu	5	-	300
1100045781	20x22Cu	5	15	120
1100045782	26x22Cu	5	15	120

Persfitting bocht met koperbuis, om te persen



Artikelnummer	Specificaties	Zak (pcs)	Doos (pcs)	Karton (pcs)
1100052131	16x15Cu - 200 mm	-	-	56
1100052132	16x15Cu - 330 mm	-	-	56

Muurplaatbocht binnendraad



Artikelnummer	Specificaties	Zak (pcs)	Doos (pcs)	Karton (pcs)
1100046442	16x1/2F	7	-	168
1100046443	20x1/2F	6	12	96
1100046444	20x3/4F	6	12	96
1100045841	26x3/4F	1	5	40

Muurplaatbocht binnendraad in U vorm



Artikelnummer	Specificaties	Zak (pcs)	Doos (pcs)	Karton (pcs)
1100052162	16x1/2Fx16	1	-	48
1100052163	20x1/2Fx16	1	-	48
1100052164	20x1/2Fx20	1	-	48
1100052165	26x1/2Fx20	1	-	32
1100052166	26x1/2Fx26	1	-	32

U aansluiting mengkraan, buitendraad



Artikelnummer	Specificaties	Zak (pcs)	Doos (pcs)	Karton (pcs)
1100050412	16x16xR1/2*M	1	-	60
1100050413	16x16xR3/4*M	1	-	60
1100050414	20x20xR1/2*M	1	-	60
1100050415	20x20xR3/4*M	1	-	60

Dubbele muurplaatbocht binnendraad 90°



Artikelnummer	Specificaties	Zak (pcs)	Doos (pcs)	Karton (pcs)
1100045907	16x1/2Fx16	5	-	90
1100045908	20x1/2Fx20	5	-	90

Rechte montagebeugel met twee muurplaatbochten



Artikelnummer	Specificaties	Zak (pcs)	Doos (pcs)	Karton (pcs)
1100052157	16x1/2F, ctc 150 mm	1	-	15
1100052158	20x1/2F, ctc 150 mm	1	-	15

Montagebeugel "Gemini" met twee muurplaatbochten



Artikelnummer	Specificaties	Zak (pcs)	Doos (pcs)	Karton (pcs)
1100052159	16x3/8F, ctc 120 mm	1	-	15
1100052160	16x1/2F, ctc 150 mm	1	-	15
1100052161	20x1/2F, ctc 150 mm	1	-	15

Montagebeugel gebogen met twee muurplaatbochten



Artikelnummer	Specificaties	Zak (pcs)	Doos (pcs)	Karton (pcs)
1100052170	16x1/2F, ctc 150 mm	1	-	16
1100052169	16x1/2F, ctc 75 mm	1	-	16

Montageplaat met twee bochten binnendraad voor gipsplaten



Artikelnummer	Specificaties	Zak (pcs)	Doos (pcs)	Karton (pcs)
1100052167	16x1/2F	-	-	16
1100052168	20x1/2F	-	-	16

Inbouwdoos met perskoppeling



Artikelnummer	Specificaties	Zak (pcs)	Doos (pcs)	Karton (pcs)
1100052155	16x1/2F	1	14	84
1100052156	20x1/2F	1	14	84

Montageplaat voor inbouwdoos



Artikelnummer	Specificaties	Zak (pcs)	Doos (pcs)	Karton (pcs)
1100052175	WBD	-	-	240

Bocht binnendraad voor droogbouw gipsplaten



Artikelnummer	Specificaties	Zak (pcs)	Doos (pcs)	Karton (pcs)
1100050408	L16x1/2F-DWT25	1	-	50
1100050409	L16x1/2F-DWT35	1	-	50

Bocht binnendraad in U vorm voor droogbouw gipsplaten



Artikelnummer	Specificaties	Zak (pcs)	Doos (pcs)	Karton (pcs)
1100050410	U16x1/2Fx16-DWT25	1	-	40
1100050411	U16x1/2Fx16-DWT35	1	-	40

Muurplaat binnendraad voor horizontale wanddoorvoer



Artikelnummer	Specificaties	Zak (pcs)	Doos (pcs)	Karton (pcs)
1100050376	S-G1/2F	1	-	70

Rechte montagebeugel uit gegalvaniseerd staal



Artikelnummer	Specificaties	Zak (pcs)	Doos (pcs)	Karton (pcs)
1100052172	MPS ctc 150 mm	-	-	160
1100052171	MPS ctc 75 mm	-	-	240

Montagebeugel "Gemini" uit gegalvaniseerd staal



Artikelnummer	Specificaties	Zak (pcs)	Doos (pcs)	Karton (pcs)
1100052173	MPG ctc 120 mm	-	-	200
1100052174	MPG ctc 150 mm	-	-	180

STEEKKOPPELINGEN



Samenstelling

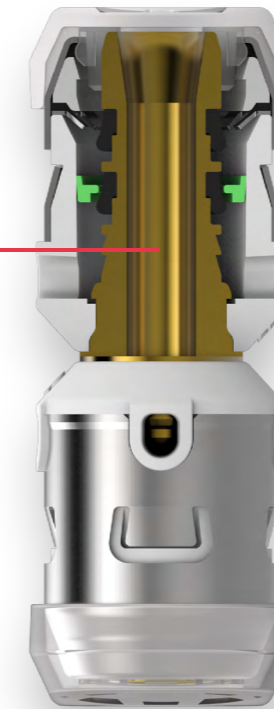

- 1 **Lichaam**
messing CW617N
- 2 **Spanhuls**
roestvrij staal 304
- 3 **Huls**
PPSU
- 4 **Grijpring**
roestvrij staal 316
- 5 **O-ringen**
EPDM
- 6 **Conische grijpring**
POM
- 7 **Indicatie**
PE
- 8 **Beschermkap**
PP

Voordelen



ZEKERHEID

Visuele bevestiging via groene indicator.



HYGIËNE

Fittingen getest volgens veilige drinkwaternormen AS/NZS 4020.



VEILIGHEID

2 afdichtingsringen, RVS grijpringen en hulzen zorgen voor veiligheid.



KWALITEIT

Hoogwaardige materialen zorgen voor uitstekende prestaties en een lange levensduur.



ONTWERP

Slank en strak ontwerp voor eenvoudig gebruik.



EENVOUDIGE INSTALLATIE

Snel en eenvoudig, geen speciaal gereedschap nodig.

Voor meerlagenbuizen en PE-X buizen: diameters 16 tot 32 mm

Doorverbinder



Artikelnummer	Specificaties	Zak (pcs)	Doos (pcs)	Karton (pcs)
1100052218	16x16	1	18	144
1100052219	20x20	1	15	120
1100052220	26x26	1	-	96
1100052221	32x32	1	-	48

Reductie



Artikelnummer	Specificaties	Zak (pcs)	Doos (pcs)	Karton (pcs)
1100052222	20x16	1	18	144
1100052223	26x16	1	-	120
1100052224	26x20	1	-	120
1100052225	32x16	1	-	72
1100052226	32x20	1	-	72
1100052227	32x26	1	-	60

Puntstuk buitendraad



Artikelnummer	Specificaties	Zak (pcs)	Doos (pcs)	Karton (pcs)
1100052228	16x1/2M	1	18	144
1100052229	16x3/4M	1	18	144
1100052230	20x1/2M	1	18	144
1100052231	20x3/4M	1	15	120
1100052232	26x3/4M	1	10	80
1100052233	26x1M	1	64	64
1100052234	32x1M	-	-	80

Puntstuk binnendraad



Artikelnummer	Specificaties	Zak (pcs)	Doos (pcs)	Karton (pcs)
1100052235	16x1/2F	1	18	144
1100052236	16x3/4F	1	12	96
1100052237	20x1/2F	1	12	96
1100052238	20x3/4F	1	12	96
1100052239	26x3/4F	1	80	80
1100052240	26x1F	1	64	64
1100052241	32x1F	1	-	80

Persfitting adapter naar Euroconus



Artikelnummer	Specificaties	Zak (pcs)	Doos (pcs)	Karton (pcs)
1100052242	16x3/4F EK	1	12	96
1100052243	20x3/4F EK	1	12	96

Stop



Artikelnummer	Specificaties	Zak (pcs)	Doos (pcs)	Karton (pcs)
1100052244	16	1	288	288
1100052245	20	1	192	192
1100052246	26	1	128	128
1100052247	32	1	-	108

T stuk



Artikelnummer	Specificaties	Zak (pcs)	Doos (pcs)	Karton (pcs)
1100052248	16x16x16	1	-	96
1100052249	20x20x20	1	-	72
1100052250	26x26x26	1	-	48
1100052251	32x32x32	1	-	24

T reductie



Artikelnummer	Specificaties	Zak (pcs)	Doos (pcs)	Karton (pcs)
1100052252	16x20x16	1	-	72
1100052253	20x16x16	1	-	72
1100052254	20x20x16	1	-	72
1100052255	20x26x20	1	-	60
1100052256	26x16x16	1	-	60
1100052257	26x16x20	1	-	60
1100052258	26x16x26	1	-	60
1100052259	26x20x16	1	-	60
1100052260	26x20x20	1	-	60
1100052261	26x20x26	1	-	40
1100052262	26x26x16	1	-	48
1100052263	26x26x20	1	-	48
1100052264	26x32x26	1	-	36
1100052265	32x16x32	1	-	48
1100052266	32x20x32	1	-	48
1100052267	32x26x32	1	-	24

T buitendraad



Artikelnummer	Specificaties	Zak (pcs)	Doos (pcs)	Karton (pcs)
1100052268	16x1/2Mx16	1	-	100
1100052269	16x3/4Mx16	1	-	100
1100052270	20x1/2Mx20	1	-	60
1100052271	20x3/4Mx20	1	-	60
1100052272	26x1/2Mx26	1	-	48
1100052273	26x3/4Mx26	1	-	48
1100052274	32x3/4Mx32	1	-	32
1100052275	32x1Mx32	1	-	32

T binnendraad



Artikelnummer	Specificaties	Zak (pcs)	Doos (pcs)	Karton (pcs)
1100052276	16x1/2Fx16	1	-	110
1100052277	16x3/4Fx16	1	-	90
1100052278	20x1/2Fx20	1	-	90
1100052279	20x3/4Fx20	1	-	72
1100052280	26x1/2Fx26	1	-	60
1100052281	26x3/4Fx26	1	-	60
1100052282	32x1/2Fx32	1	-	40
1100052283	32x3/4Fx32	1	-	40
1100052284	32x1Fx32	1	-	40

Bocht 90°



Artikelnummer	Specificaties	Zak (pcs)	Doos (pcs)	Karton (pcs)
1100052285	16x16	1	12	96
1100052286	20x20	1	-	120
1100052287	26x26	1	-	80
1100052288	32x32	1	-	42

Bocht buitendraad 90°



Artikelnummer	Specificaties	Zak (pcs)	Doos (pcs)	Karton (pcs)
1100052289	16x1/2M	1	18	144
1100052290	16x3/4M	1	12	96
1100052291	20x1/2M	1	10	80
1100052292	20x3/4M	1	10	80
1100052293	26x3/4M	1	-	96
1100052294	26x1M	1	-	80
1100052295	32x1M	1	-	48

Bocht binnendraad 90°



Artikelnummer	Specificaties	Zak (pcs)	Doos (pcs)	Karton (pcs)
1100052296	16x1/2F	1	12	96
1100052297	16x3/4F	1	14	112
1100052298	20x1/2F	1	10	80
1100052299	20x3/4F	1	10	80
1100052300	26x3/4F	1	-	72
1100052301	26x1F	1	-	72
1100052302	32x1F	1	-	48

Muurplaatbocht binnendraad



Artikelnummer	Specificaties	Zak (pcs)	Doos (pcs)	Karton (pcs)
1100052303	16x1/2F	1	-	144
1100052304	20x1/2F	1	-	120
1100052305	20x3/4F	1	-	96
1100052306	26x3/4F	1	-	60

KNELKOPPELINGEN

Samenstelling

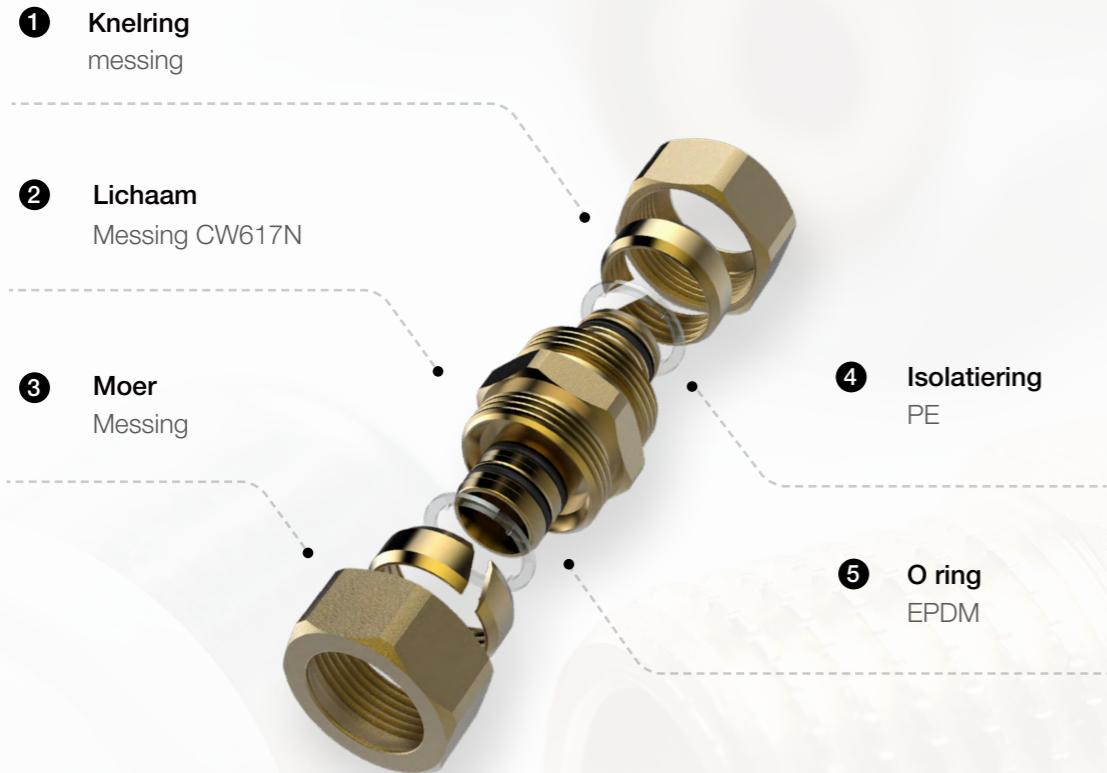

Voordelen



Herbruikbaar



Uitstekende afdichtingsprestaties met dubbele O-ring



Gemak en veiligheid van installatie

Voor meerlagenbuis en PE-X: diameters 12 tot 32 mm

Doorverbinder



Artikelnummer	Specificaties	Zak (pcs)	Doos (pcs)	Karton (pcs)
1100045672	16x16	6	24	192
1100045673	20x20	5	20	160
1100052176	25x25	7	14	112
1100045674	26x26	7	14	112
1100052177	32x32	6	-	96

Reductie



Artikelnummer	Specificaties	Zak (pcs)	Doos (pcs)	Karton (pcs)
1100045675	20x16	6	24	192
1100052178	25x16	5	15	120
1100045676	26x16	5	15	120
1100045677	26x20	5	15	120
1100052179	32x16	4	-	96
1100052180	32x20	4	-	96
1100052181	32x25	6	-	64

Puntstuk buitendraad



Artikelnummer	Specificaties	Zak (pcs)	Doos (pcs)	Karton (pcs)
1100045686	16x1/2M	6	36	288
1100045687	16x3/4M	5	25	200
1100045689	20x1/2M	6	24	192
1100045690	20x3/4M	6	24	192
1100052182	25x3/4M	4	16	128
1100052183	25x1M	4	16	128
1100045691	26x3/4M	4	16	128
1100045692	26x1M	8	16	128
1100052184	32x1M	6	-	108

Puntstuk binnendraad



Artikelnummer	Specificaties	Zak (pcs)	Doos (pcs)	Karton (pcs)
1100045680	16x1/2F	5	30	240
1100045681	16x3/4F	5	25	200
1100045682	20X1/2F	5	30	240
1100045683	20X3/4F	5	25	200
1100052185	25x3/4F	5	20	160
1100045684	26x3/4F	5	20	160
1100052186	25x1F	4	16	128
1100045685	26x1F	8	16	128
1100052187	32x1F	6	-	108

T stuk



Artikelnummer	Specificaties	Zak (pcs)	Doos (pcs)	Karton (pcs)
1100045700	16x16x16	6	12	96
1100045701	20x20x20	4	12	96
1100052188	25x25x25	4	-	48
1100045702	26x26x26	4	6	48
1100052189	32x32x32	4	-	36

T reductie



Artikelnummer	Specificaties	Zak (pcs)	Doos (pcs)	Karton (pcs)
1100045703	16x20x16	5	10	80
1100045704	20x16x20	5	10	80
1100052190	25x16x25	-	-	56
1100052191	25x20x25	4	7	56
1100045705	26x16x26	4	7	56
1100052192	25x20x16	-	-	48
1100052193	32x16x32	-	-	48
1100052194	32x20x32	4	-	44
1100052195	32x25x32	4	-	44

T buitendraad



Artikelnummer	Specificaties	Zak (pcs)	Doos (pcs)	Karton (pcs)
1100045697	16x1/2Mx16	5	15	120
1100045698	20x1/2Mx20	5	10	80

T binnendraad



Artikelnummer	Specificaties	Zak (pcs)	Doos (pcs)	Karton (pcs)
1100052196	16x3/4Fx16	-	-	80
1100045694	20x1/2Fx20	4	12	96
1100045695	20x3/4Fx20	4	8	64
1100052197	25x3/4Fx25	-	-	56
1100045696	26x3/4Fx26	4	7	56
1100052198	32x1Fx32	-	-	48

Bocht 90°



Artikelnummer	Specificaties	Zak (pcs)	Doos (pcs)	Karton (pcs)
1100045707	16x16	5	15	120
1100045708	20x20	5	15	120
1100052199	25x25	5	10	80
1100045709	26x26	5	10	80
1100052200	32x32	4	-	48

Bocht buitendraad 90°



Artikelnummer	Specificaties	Zak (pcs)	Doos (pcs)	Karton (pcs)
1100045710	16x1/2M	5	20	160
1100052201	16x3/4M	-	-	120
1100045711	20x1/2M	8	16	128
1100052202	20x3/4M	8	16	128
1100052203	25x3/4M	6	12	96
1100052204	25x1M	-	-	80
1100045712	26x3/4M	6	12	96
1100045713	26x1M	1	10	80
1100052205	32x3/4M	-	-	72

Bocht binnendraad 90°



Artikelnummer	Specificaties	Zak (pcs)	Doos (pcs)	Karton (pcs)
1100045714	16x1/2F	5	20	160
1100045715	20x1/2F	5	15	120
1100045716	20x3/4F	5	15	120
1100052206	25x3/4F	6	12	96
1100052207	25x1F	-	-	72
1100045717	26x3/4F	6	12	96
1100045718	26x1F	1	9	72
1100052208	32x1F	5	-	60

Muurplaatbocht binnendraad



Artikelnummer	Specificaties	Zak (pcs)	Doos (pcs)	Karton (pcs)
1100045719	16x1/2F	7	14	112
1100045720	20x1/2F	6	12	96

Inbouwdoos met knelkoppeling



Artikelnummer	Specificaties	Zak (pcs)	Doos (pcs)	Karton (pcs)
1100052210	16x1/2F	-	-	84
1100052211	20x1/2F	-	-	84

Montageplaat voor inbouwdoos



Artikelnummer	Specificaties	Zak (pcs)	Doos (pcs)	Karton (pcs)
1100052175	WBD	-	-	240

Knelkoppeling M24 x 16



Artikelnummer	Specificaties	Zak (pcs)	Doos (pcs)	Karton (pcs)
1100052212	16xM24	-	-	384

Koppeling voor ombouw knelkoppeling koper naar knelkoppeling meerlagenbuis



Artikelnummer	Specificaties	Zak (pcs)	Doos (pcs)	Karton (pcs)
1100045678	16x15Cu	-	-	288
1100045679	20x22Cu	-	-	120
1100052209	26x28Cu	-	-	64

Euroconus knelkoppeling 3/4"F



Artikelnummer	Specificaties	Zak (pcs)	Doos (pcs)	Karton (pcs)
1100052213	14x3/4F EK	-	-	360
1100052214	16x3/4F EK	-	-	360
1100052215	17x3/4F EK	-	-	360
1100052216	18x3/4F EK	-	-	360
1100052217	20x3/4F EK	-	-	360

Euroconus 3/4" M doorverbinder



Artikelnummer	Specificaties	Zak (pcs)	Doos (pcs)	Karton (pcs)
1100052133	3/4M EK x 3/4M EK	-	-	160

Euroconus 3/4" M overgang naar 1/2" buitendraad met O-ring



Artikelnummer	Specificaties	Zak (pcs)	Doos (pcs)	Karton (pcs)
1100052134	3/4M EK x 1/2M O-ring	-	-	256

Euroconus 3/4" M T stuk



Artikelnummer	Specificaties	Zak (pcs)	Doos (pcs)	Karton (pcs)
1100052135	3/4M EK x 3/4M EK x 3/4M EK	-	-	160

Euroconus 3/4" M bocht



Artikelnummer	Specificaties	Zak (pcs)	Doos (pcs)	Karton (pcs)
1100052136	3/4M EK x 3/4M EK	-	-	160

Euroconus 3/4" M overgang naar buitendraad 1/2"M



Artikelnummer	Specificaties	Zak (pcs)	Doos (pcs)	Karton (pcs)
1100052137	3/4M EK x 1/2M	-	-	160

VERDELERS

Messing verdeler 3/4" met stopkranen en euroconus aansluitingen



Artikelnummer	Specificaties	Zak (pcs)	Doos (pcs)	Karton (pcs)
1100048843	3/4 - 3/4EK x 2 red	1	8	48
1100048844	3/4 - 3/4EK x 3 red	1	6	36
1100048845	3/4 - 3/4EK x 4 red	1	4	24
1100048837	3/4 - 3/4EK x 2 blue	1	8	48
1100048838	3/4 - 3/4EK x 3 blue	1	6	36
1100048839	3/4 - 3/4EK x 4 blue	1	4	24

Adapter met vlakke dichting voor verdeler met O-ring, buitendraad met O-ring



Artikelnummer	Specificaties	Zak (pcs)	Doos (pcs)	Karton (pcs)
1100048347	3/4Mx3/4F(H)	1	30	240
1100048348	1Mx1F(H)	1	16	128

Adapter met vlakke dichting voor verdeler met O-ring, binnendraad



Artikelnummer	Specificaties	Zak (pcs)	Doos (pcs)	Karton (pcs)
1100048349	3/4Fx3/4F(H)	1	24	192
1100048350	1Fx1F(H)	1	16	128

Vernikkeld eindstuk met O-ring voor verdeler, binnendraad



Artikelnummer	Specificaties	Zak (pcs)	Doos (pcs)	Karton (pcs)
1100048319	3/4F	1	32	256
1100048320	1F	1	30	240

Vernikkeld eindstuk met O-ring voor verdeler, buitendraad

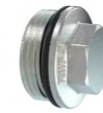

Artikelnummer	Specificaties	Zak (pcs)	Doos (pcs)	Karton (pcs)
1100048317	3/4M	1	45	360
1100048318	1M	1	32	256

Eindstuk voor verdeler met O-ring, buitendraad met O-ring



Artikelnummer	Specificaties	Zak (pcs)	Doos (pcs)	Karton (pcs)
1100048324	1M(H)x1/2Fx1/2F	1	12	96

Manuele ontluucher



Artikelnummer	Specificaties	Zak (pcs)	Doos (pcs)	Karton (pcs)
1100048321	1/2M-AV	1	52	416

Vul-en aftapkraan voor eindstuk verdeler



Artikelnummer	Specificaties	Zak (pcs)	Doos (pcs)	Karton (pcs)
1100048322	1/2M-DV	1	24	192

Beugel voor verdeler



Artikelnummer	Specificaties	Zak (pcs)	Doos (pcs)	Karton (pcs)
1100048650	3/4-1 - D 200 mm			

Adapters

Reductienippel, buitendraadmet o-ring - binnendraad



Artikelnummer	Specificaties	Zak (pcs)	Doos (pcs)	Karton (pcs)
1100048492	3/4M x 1/2F	1	45	360
1100048493	1M x 3/4F	1	24	192

Dubbele nippel buitendraad



Artikelnummer	Specificaties	Zak (pcs)	Doos (pcs)	Karton (pcs)
1100052348	1/2M x 1/2M	1	48	384
1100052349	3/4M x 3/4M	1	31	248
1100052350	1M x 1M	1	18	144

Dubbele nippel binnendraad



Artikelnummer	Specificaties	Zak (pcs)	Doos (pcs)	Karton (pcs)
1100048360	1/2F x 1/2F	1	52	416
1100048361	3/4F x 3/4F	1	30	240
1100048363	1F x 1F	1	18	144

Rechte nippel, buitendraad - binnendraad



Artikelnummer	Specificaties	Zak (pcs)	Doos (pcs)	Karton (pcs)
1100048369	1/2M x 1/2F	1	45	360
1100048362	3/4M x 3/4F	1	30	240
1100048364	1M x 1F	1	16	128

Reductienippel, buitendraad - binnendraad



Artikelnummer	Specificaties	Zak (pcs)	Doos (pcs)	Karton (pcs)
1100048365	3/4M x 1/2F	1	45	360
1100048366	1M x 1/2F	1	24	192
1100048367	1M x 3/4F	1	24	192
1100048368	1 1/4M x 1F	1	20	160
1100048370	1 1/2M x 1F	1	16	128

T nippel, binnendraad



Artikelnummer	Specificaties	Zak (pcs)	Doos (pcs)	Karton (pcs)
1100048357	1/2F x 1/2F x 1/2F	1	24	192
1100048358	3/4F x 3/4F x 3/4F	1	16	128
1100048359	1F x 1F x 1F	1	10	80

Bocht nippel binnendraad



Artikelnummer	Specificaties	Zak (pcs)	Doos (pcs)	Karton (pcs)
1100048351	1/2F x 1/2F	1	32	256
1100048352	3/4F x 3/4F	1	20	160
1100048353	1F x 1F	1	16	128

Bocht nippel, buitendraad - binnendraad



Artikelnummer	Specificaties	Zak (pcs)	Doos (pcs)	Karton (pcs)
1100048351	1/2F x 1/2F	1	32	256
1100048352	3/4F x 3/4F	1	20	160
1100048353	1F x 1F	1	16	128

PE-X LEIDINGSYSTEEM

PE-X buizen

Samenstelling

RIIFO PE-Xb buis is gemaakt van vernet polyethyleen. RIIFO maakt gebruik van de productiemethode van silaan vernetting die PE-Xb buis superieure chemische en mechanische prestaties biedt.

RIIFO heeft buizen met of zonder zuurstofbarrière. De barrière verhindert het binnendringen van zuurstof in het leidingsysteem. De zuurstofbarrière wordt gevormd door een specifieke synthetische laag, vaak EVOH genoemd.

PE-Xb leidingen zonder zuurstofbarrière worden toegepast in 'open systemen'. Sanitaire systemen zijn open systemen: vanaf het moment dat je de douche- of wastafelkraan aanzet, staat het systeem open voor zuurstof. De zuurstof kan vrij in het leidingsysteem doordringen.

Daarom wordt bij gebruik van volledig synthetische leidingen voor sanitaire toepassingen zelden een zuurstofbarrière gebruikt.

Leidingen met een zuurstofbarrière worden toegepast in zogenaamde "gesloten systemen". Verwarmings- of vloerverwarmingssystemen zijn gesloten systemen. Vanaf het moment dat deze systemen gevuld en ontluicht zijn, blijven ze gesloten. Om te voorkomen dat zuurstof doorheen de PE binnendringt, worden PEX-leidingen met zuurstofbarrière gebruikt. Zuurstof in een systeem moet zoveel mogelijk worden vermeden, omdat het een oorzaak van corrosie is en na verloop van tijd de prestaties van het systeem zal verminderen.

Voordelen



Zeer flexibel en eenvoudig te installeren



Uitstekend corrosie- en chloorbestendig



Lichtgewicht. 4 keer lichter dan metalen buizen.



Hygiënisch en loodvrij.

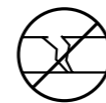

Barstbestendig, zelfs tijdens ijzige dagen



Levensduur van meer dan 50 jaar





Artikelnummer	Specificaties	Rol (m)
1100049644	16 x 1,5	100
1100049645	16 x 1,8	100
1100049646	16 x 2,0	100
1100049647	16 x 2,2	100
1100049648	18 x 2,0	100
1100049649	20 x 1,9	100
1100049650	20 x 2,0	100
1100049651	20 x 2,3	50
1100049652	20 x 2,8	50
1100049653	25 x 2,3	50
1100049654	25 x 2,5	50
1100052111	25 x 2,8	50
1100052112	32 x 3,0	50



Artikelnummer	Specificaties	Rol (m)
1100052113	16 x 1,5	100
1100052114	16 x 1,8	100
1100052115	16 x 2,0	100
1100052116	16 x 2,2	100
1100052117	20 x 1,9	100
1100052118	20 x 2,0	100
1100052119	20 x 2,3	50
1100052120	25 x 2,3	50
1100052121	25 x 2,5	50
1100052122	32 x 3,0	50

Fittingen voor PE-X

PE-Xb buizen met of zonder zuurstofbarrière in de diameters 16x2, 20x2, 25x2,5 en 32x3 kunnen gebruikt worden in combinatie met de volgende fittingen van dezelfde afmetingen:



Multiprofiel persfittingen



Push fittingen



Knelkoppelingen

VLOERVERWARMINGSSYSTEEM



BUIZEN

PE-RT met zuurstofbarrière



Artikelnummer	Specificaties	Rol (m)	Pallet (m)
1100049655	14 x 2	600	3000
1100049604	16 x 2	120	1800
1100049656	16 x 2	200	1600
1100049675	16 x 2	400	1600
1100049676	16 x 2	500	2000
1100049657	16 x 2	600	2400
1100049658	17 x 2	600	2400
1100049659	18 x 2	500	1500
1100049660	18 x 2	600	1800
1100049661	20 x 2	120	1440
1100049662	20 x 2	500	1500
1100049663	20 x 2	600	1800

PE-Xb met zuurstofbarrière



Artikelnummer	Specificaties	Rol (m)	Pallet (m)
1100049637	PEX16-120	16 x 2	
1100049638	PEX16-200	16 x 2	
1100049639	PEX16-400	16 x 2	
1100049640	PEX20-120	20 x 2	
1100049641	PEX20-200	20 x 2	

PE-X/AL/PE-X meerlagenbuizen



Artikelnummer	Specificaties	Rol (m)	Pallet (m)
1100044539	B1-1216-120	16 x 2	
1100042675	B1-1216-500	16 x 2	

VERDELERS

Roestvrijstalen verdeler + bolkranen met thermometers + regelbare debietmeters 1-5l/min en inregelkranen + automatische ontluichters + vul-en aftapkranen + euroconus aansluitingen

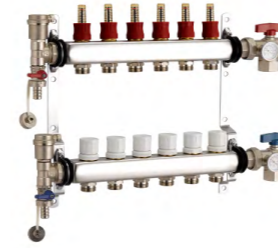

Artikelnummer	Specificaties	Box (pc.)
1100042446	1F-005-3/4EK-02	1
1100042447	1F-005-3/4EK-03	1
1100042448	1F-005-3/4EK-04	1
1100042449	1F-005-3/4EK-05	1
1100042450	1F-005-3/4EK-06	1
1100042451	1F-005-3/4EK-07	1
1100042452	1F-005-3/4EK-08	1
1100042453	1F-005-3/4EK-09	1
1100042454	1F-005-3/4EK-10	1
1100042455	1F-005-3/4EK-11	1
1100042456	1F-005-3/4EK-12	1

Messing verdeler + bolkranen met thermometers + regelbare debietmeters 1-5l/min en inregelkranen + automatische ontluichters + vul-en aftapkranen + euroconus aansluitingen

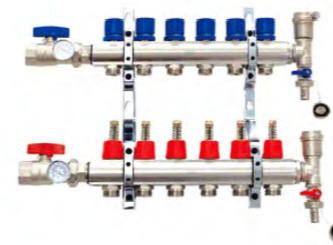

Artikelnummer	Specificaties	Box (pc.)
1100042280	1F-005-3/4EK-02	1
1100042281	1F-005-3/4EK-03	1
1100042282	1F-005-3/4EK-04	1
1100042283	1F-005-3/4EK-05	1
1100042284	1F-005-3/4EK-06	1
1100042285	1F-005-3/4EK-07	1
1100042286	1F-005-3/4EK-08	1
1100042287	1F-005-3/4EK-09	1
1100042288	1F-005-3/4EK-10	1
1100042289	1F-005-3/4EK-11	1
1100042290	1F-005-3/4EK-12	1

TOEBEHOREN VERDELERS

Composiet verdeler + bolkranen + thermometers + regelbare debietmeters 0-2,5l/min en inregelkranen + automatische ontlueters + vul-en aftapkranen + euroconus aansluitingen

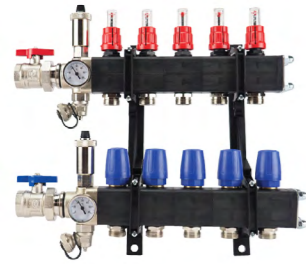

Artikelnummer	Specificaties	Box (pc.)
1100052489	1F-025-3/4EK-02	1
1100052490	1F-025-3/4EK-03	1
1100052491	1F-025-3/4EK-04	1
1100052492	1F-025-3/4EK-05	1
1100052493	1F-025-3/4EK-06	1
1100052494	1F-025-3/4EK-07	1
1100052495	1F-025-3/4EK-08	1
1100052496	1F-025-3/4EK-09	1
1100052497	1F-025-3/4EK-10	1
1100052498	1F-025-3/4EK-11	1
1100052499	1F-025-3/4EK-12	1

Composiet verdeler + bolkranen + thermometers + regelbare debietmeters 0-5l/min en inregelkranen + automatische ontlueters + vul-en aftapkranen + euroconus aansluitingen



Artikelnummer	Specificaties	Box (pc.)
1100052511	1F-025-3/4EK-02	1
1100052512	1F-025-3/4EK-03	1
1100052513	1F-025-3/4EK-04	1
1100052514	1F-025-3/4EK-05	1
1100052515	1F-025-3/4EK-06	1
1100052516	1F-025-3/4EK-07	1
1100052517	1F-025-3/4EK-08	1
1100052518	1F-025-3/4EK-09	1
1100052519	1F-025-3/4EK-10	1
1100052520	1F-025-3/4EK-11	1
1100052521	1F-025-3/4EK-12	1

Composiet verdeler + bolkranen + thermometers + regelbare debietmeters 0-5l/min en inregelkranen + automatische ontlueters + vul-en aftapkranen + euroconus aansluitingen

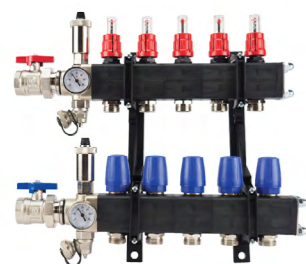

Artikelnummer	Specificaties	Box (pc.)
1100052500	1F-005-3/4EK-02	1
1100052501	1F-005-3/4EK-03	1
1100052502	1F-005-3/4EK-04	1
1100052503	1F-005-3/4EK-05	1
1100052504	1F-005-3/4EK-06	1
1100052505	1F-005-3/4EK-07	1
1100052506	1F-005-3/4EK-08	1
1100052507	1F-005-3/4EK-09	1
1100052508	1F-005-3/4EK-10	1
1100052509	1F-005-3/4EK-11	1
1100052510	1F-005-3/4EK-12	1

VERDELERS TOEBEHOREN

Set kogelkranen 1" met thermometer voor messing en inoxen verdelers



Artikelnummer	Specificaties	Zak (pcs)	Doos (pcs)	Karton (pcs)
1100047700	1F - 1M	2		18

Set kogelkranen 1" met thermometer, haaks, voor messing en inoxen verdelers



Artikelnummer	Specificaties	Zak (pcs)	Doos (pcs)	Karton (pcs)
1100047698	1F - 1M	2		18

Set kogelkranen 1" met thermometer voor composiet verdelers



Artikelnummer	Specificaties	Zak (pcs)	Doos (pcs)	Karton (pcs)
1100052522	1F - 1M	2		

Set kogelkranen 1", haaks



Artikelnummer	Specificaties	Zak (pcs)	Doos (pcs)	Karton (pcs)
1100052523	1F - 1M	2		

Manuele ontluchter



Artikelnummer	Specificaties	Zak (pcs)	Doos (pcs)	Karton (pcs)
1100048321	1/2M-AV			416

Thermometer for angled ball valve



Artikelnummer	Specificaties	Zak (pcs)	Doos (pcs)	Karton (pcs)
1100052564	P-T	2		

Automatische ontluchter



Artikelnummer	Specificaties	Zak (pcs)	Doos (pcs)	Karton (pcs)
1100052565	1/2M-AA	1		

Eindstuk met automatische ontluchter, vul-en aftapkraan voor messing en edelstalen verdelers



Artikelnummer	Specificaties	Zak (pcs)	Doos (pcs)	Karton (pcs)
1100047703	1M	2		24

Eindstuk met manuele ontluchter, vul-en aftapkraan voor messing en edelstalen verdelers



Artikelnummer	Specificaties	Zak (pcs)	Doos (pcs)	Karton (pcs)
1100047702	1M	2		24

Pompgroep voor constante temperatuurregeling



Artikelnummer	Specificaties	Zak (pcs)	Doos (pcs)	Karton (pcs)
1100052566	1M		1	

SYSTEEMCOMPONENTEN

Randisolatie met voorgevormde scheurstroken en folieoverlapping



Artikelnummer	Specificaties	Zak (pcs)	Doos (pcs)	Karton (pcs)
1100052570	150 x 8 mm	25 m		

Randisolatie met voorgevormde scheurstroken, folieoverlapping en kleefstrook, ideal voor gietvloeren



Artikelnummer	Specificaties	Zak (pcs)	Doos (pcs)	Karton (pcs)
1100052571	150 x 8 mm	25 m		

Folie, beschermend dampscherm met rastermarkering



Artikelnummer	Specificaties	Zak (pcs)	Doos (pcs)	Karton (pcs)
1100052572	50 m x 1m	50 m		

Folie, beschermend dampscherm met aluminiumreflectie

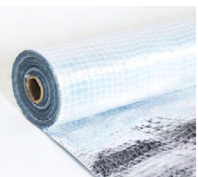

Artikelnummer	Specificaties	Zak (pcs)	Doos (pcs)	Karton (pcs)
1100052573	50 m x 1,5 m x 0,20 mm	50 m		

Verankeringsclip voor dampfolie



Artikelnummer	Specificaties	Zak (pcs)	Doos (pcs)	Karton (pcs)
1100052574			200	5,600

Isolatieplaat voorzien van folie met rastermarkering

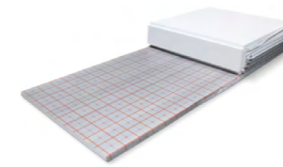

Artikelnummer	Specificaties	Zak (pcs)	Doos (pcs)	Karton (pcs)
1100052575	10 m - 1 m - 20 mm	10 m ²		
1100052576	10 m - 1 m - 30 mm	10 m ²		

Tackernagel 40 mm, gelast



Artikelnummer	Specificaties	Zak (pcs)	Doos (pcs)	Karton (pcs)
1100052556	40 mm		300	8,400

Tackernagel 40 mm met papieren tape



Artikelnummer	Specificaties	Zak (pcs)	Doos (pcs)	Karton (pcs)
1100052556	40 mm		300	8,400

Tackernagel 50 mm, gelast



Artikelnummer	Specificaties	Zak (pcs)	Doos (pcs)	Karton (pcs)
1100052558	50 mm	250	250	7,000

Tackernagel 50 mm met papieren tape



Artikelnummer	Specificaties	Zak (pcs)	Doos (pcs)	Karton (pcs)
1100052559	50 mm	250	250	7,000

Tackernagel 60 mm, gelast



Artikelnummer	Specificaties	Zak (pcs)	Doos (pcs)	Karton (pcs)
1100052560	60 mm	300	300	6,000

Tackernagel 60 mm met papieren tape



Artikelnummer	Specificaties	Zak (pcs)	Doos (pcs)	Karton (pcs)
1100052561	60 mm	300	300	6,000

Ankerclip voor handmatig gebruik



Artikelnummer	Specificaties	Zak (pcs)	Doos (pcs)	Karton (pcs)
1100052563	40 mm	200	200	5,600

Tackerapparaat



Artikelnummer	Specificaties	Zak (pcs)	Doos (pcs)	Karton (pcs)
1100052562	For TACK-40-50-60		1	

Geleidingsbocht voor buis 90°



Artikelnummer	Specificaties	Zak (pcs)	Doos (pcs)	Karton (pcs)
1100052527	14-18 mm		20	400

Gegalvaniseerde staaldraadmatten



Artikelnummer	Specificaties	Zak (pcs)	Doos (pcs)	Karton (pcs)
1100052577	100 x 100 mm - 2,52 m ²	10		
1100052578	150 x 150 mm - 2,52 m ²	10		

Afrolhaspel



Artikelnummer	Specificaties	Zak (pcs)	Doos (pcs)	Karton (pcs)
1100052528	25 - 600 m		1	

PP-R SYSTEEM

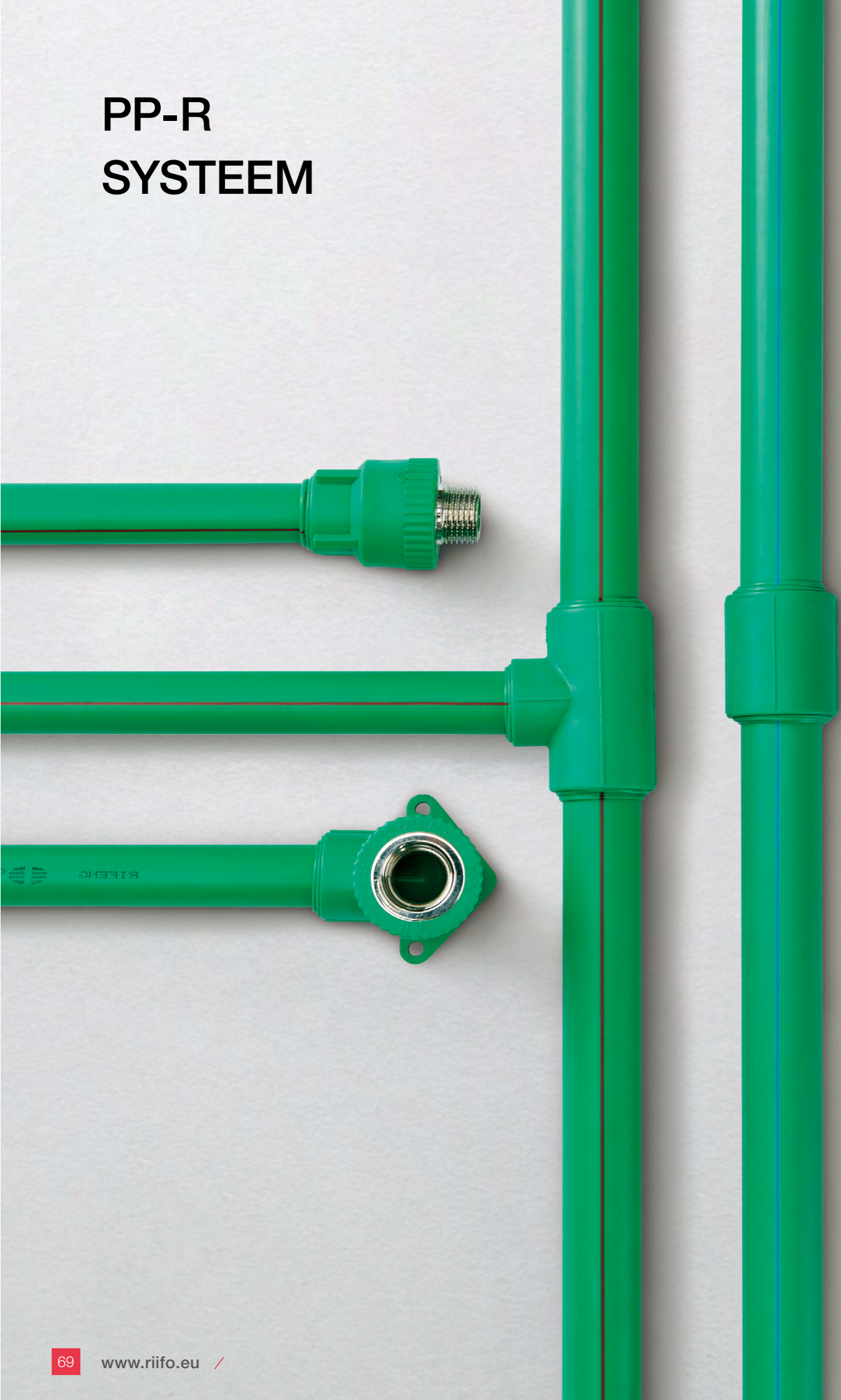

PP-R buizen

Samenstelling

RIIFO PP-R leidingsysteem, gemaakt van hoogwaardig polypropyleen random copolymeer, kan worden toegepast in zowel residentiële als commerciële gebouwen. RIIFO zet zich al meer dan 20 jaar in om een breed assortiment PP-R buizen en hulpstukken te produceren die voldoen aan EN ISO 15874. Van enkellaagse tot meerlaagse PP-R buis, van groen, grijs tot wit gekleurde buis. Vezelcomposiet PP-R buis. 3-laags structuurontwerp met glasvezels, stabiel en betrouwbaar. Lage lineaire uitzetting en verbeterde temperatuurbestendigheid. Basaltvezel PP-R buis. Basaltvezel is een nieuw type anorganisch, milieuvriendelijk en hoogwaardig vezelmateriaal. De basaltvezel van ruimtevaartkwaliteit

heeft een enorme drukbestendigheid. De lineaire uitzettingscoëfficiënt van de basaltvezelbuis is 3 keer lager dan die van gewone PP-R-buis en heeft een uitstekende temperatuurbestendigheid. PP-RCT buizen. Het moderne PP-RCT materiaal verbetert de kristallijne structuur van het PP. Hierdoor kunnen de leidingen bij hogere drukken en temperaturen werken. Door de sterkte van het materiaal kunnen de buizen een dunnere wanddikte en bijgevolg een groter debiet hebben. Men kan kiezen voor kleinere diameters wat geld bespaart. De PP-RCT buizen hebben ook een lage temperatuur slagvastheid.

Voordelen



Roestvrij



Lichtgewicht Hygiënisch



Uitstekende warmte- en geluidsisolatie



Gladde binnenwand



Breed assortiment: vezelcomposiet, basalt composiet, PP-RCT

Normen

- DVGW W544
- NSF 61
- UNE EN ISO 15874

Certificaten



Eenlagige PP-R buis S 2,5 - SDR 6



Artikelnummer	Specificaties	Zak (pcs)	Doos (pcs)	Karton (pcs)
1100052019	20x3.4 - white	40	white	160(4x40)
1100042826	20x3.4 - green	40	green	160(4x40)
1100052020	25x4.2 - white	32	white	128(4x32)
1100042827	25x4.2 - green	32	green	128(4x32)
1100052021	32x5.4 - white	16	white	64(4x16)
1100041810	32x5.4 - green	16	green	64(4x16)
1100052022	40x6.7 - white	48	white	48(4x12)
1100041811	40x6.7 - green	48	green	48(4x12)
1100052023	50x8.3 - white	28	white	28(4x7)
1100041812	50x8.3 - green	28	green	28(4x7)
1100052024	63x10.5 - white	20	white	20(4x5)
1100041813	63x10.5 - green	20	green	20(4x5)
1100052025	75x12.5 - white	16	white	16(4x4)
1100044967	75x12.5 - green	16	green	16(4x4)
1100052026	90x15 - white	12	white	12(4x3)
1100044968	90x15 - green	12	green	12(4x3)
1100052027	110x18.3 - white	8	white	8(4x2)
1100044969	110x18.3 - green	8	green	8(4x2)
1100052028	160x26.6 - white	4	white	4(4x1)
1100052029	160x26.6 - green	4	green	4(4x1)

Eenlagige PP-R buis S 4 - SDR 9



Artikelnummer	Specificaties	Zak (pcs)	Doos (pcs)	Karton (pcs)
1100052039	20x2.3 - white	40	white	160(4x40)
1100042832	20x2.3 - green	40	green	160(4x40)
1100052040	25x2.8 - white	32	white	128(4x32)
1100042833	25x2.8 - green	32	green	128(4x32)
1100052041	32x3.6 - white	16	white	64(4x16)
1100042834	32x3.6 - green	16	green	64(4x16)
1100052042	40x4.5 - white	48	white	48(4x12)
1100042835	40x4.5 - green	48	green	48(4x12)
1100052043	50x5.6 - white	28	white	28(4x7)
1100042836	50x5.6 - green	28	green	28(4x7)
1100052044	63x7.1 - white	20	white	20(4x5)
1100042837	63x7.1 - green	20	green	20(4x5)
1100052075	75x8.4 - white	16	white	16(4x4)
1100052045	75x8.4 - green	16	green	16(4x4)
1100052046	90x10.1 - white	12	white	12(4x3)
1100052047	90x10.1 - green	12	green	12(4x3)
1100052048	110x12.3 - white	8	white	8(4x2)
1100052049	110x12.3 - green	8	green	8(4x2)
1100052050	160x17.9 - white	4	white	4(4x1)
1100052051	160x17.9 - green	4	green	4(4x1)

Eenlagige PP-R buis S 3,2 - SDR 7,4



Artikelnummer	Specificaties	Zak (pcs)	Doos (pcs)	Karton (pcs)
1100050209	20x2.8 - white	40	white	160(4x40)
1100042828	20x2.8 - green	40	green	160(4x40)
1100050031	25x3.5 - white	32	white	128(4x32)
1100042829	25x3.5 - green	32	green	128(4x32)
1100050032	32x4.4 - white	16	white	64(4x16)
1100042830	32x4.4 - green	16	green	64(4x16)
1100050033	40x5.5 - white	48	white	48(4x12)
1100042831	40x5.5 - green	48	green	48(4x12)
1100050210	50x6.9 - white	28	white	28(4x7)
1100052030	50x6.9 - green	28	green	28(4x7)
1100050211	63x8.6 - white	20	white	20(4x5)
1100050537	63x8.6 - green	20	green	20(4x5)
1100052031	75x10.3 - white	16	white	16(4x4)
1100052032	75x10.3 - green	16	green	16(4x4)
1100052033	90x12.3 - white	12	white	12(4x3)
1100052034	90x12.3 - green	12	green	12(4x3)
1100052035	110x15.1 - white	8	white	8(4x2)
1100052036	110x15.1 - green	8	green	8(4x2)
1100052037	160x21.9 - white	4	white	4(4x1)
1100052038	160x21.9 - green	4	green	4(4x1)

Eenlagige PP-R buis S 5 - SDR 11



Artikelnummer	Specificaties	Zak (pcs)	Doos (pcs)	Karton (pcs)
1100050034	20x2.0 - White	40	white	160(4x40)
1100042838	20x2.0 - Green	40	green	160(4x40)
1100050205	25x2.3 - White	32	white	128(4x32)
1100042839	25x2.3 - Green	32	green	128(4x32)
1100050206	32x2.9 - White	16	white	64(4x16)
1100042840	32x2.9 - Green	16	green	64(4x16)
1100050207	40x3.7 - White	48	white	48(4x12)
1100042841	40x3.7 - Green	48	green	48(4x12)
1100050208	50x4.6 - White	28	white	28(4x7)
1100042842	50x4.6 - Green	28	green	28(4x7)
1100050212	63x5.8 - White	20	white	20(4x5)
1100042843	63x5.8 - Green	20	green	20(4x5)
1100052052	75x6.8 - White	16	white	16(4x4)
1100044964	75x6.8 - Green	16	green	16(4x4)
1100052053	90x8.2 - White	12	white	12(4x3)
1100044965	90x8.2 - Green	12	green	12(4x3)
1100052063	110x10 - White	8	white	8(4x2)
1100044966	110x10 - Green	8	green	8(4x2)
1100052064	160x14.6 - White	4	white	4(4x1)
1100052065	160x14.6 - Green	4	green	4(4x1)

PP-R meerlagenbuis met glasvezel S 2,5 - SDR 6



Artikelnummer	Specificaties	Zak (pcs)	Doos (pcs)	Karton (pcs)
1100046976	20x3.4 - white	40	white	160(4x40)
1100052066	20x3.4 - green	40	green	160(4x40)
1100046977	25x4.2 - white	32	white	128(4x32)
1100052067	25x4.2 - green	32	green	128(4x32)
1100046978	32x5.4 - white	16	white	64(4x16)
1100052068	32x5.4 - green	16	green	64(4x16)
1100046979	40x6.7 - white	48	white	48(4x12)
1100052069	40x6.7 - green	48	green	48(4x12)
1100046980	50x8.3 - white	28	white	28(4x7)
1100052070	50x8.3 - green	28	green	28(4x7)
1100046981	63x10.5 - white	20	white	20(4x5)
1100052071	63x10.5 - green	20	green	20(4x5)
1100046982	75x12.5 - white	16	white	16(4x4)
1100052072	75x12.5 - green	16	green	16(4x4)
1100046983	90x15 - white	12	white	12(4x3)
1100052073	90x15 - green	12	green	12(4x3)
1100046984	110x18.3 - white	8	white	8(4x2)
1100052074	110x18.3 - green	8	green	8(4x2)
1100052028	160x26.6 - white	4	white	4(4x1)
1100052029	160x26.6 - green	4	green	4(4x1)

PP-R meerlagenbuis met glasvezel S 3,2 - SDR 7,4



Artikelnummer	Specificaties	Zak (pcs)	Doos (pcs)	Karton (pcs)
1100046973	20x2.8 - white	40	white	160(4x40)
1100052054	20x2.8 - green	40	green	160(4x40)
1100046974	25x3.5 - white	32	white	128(4x32)
1100052055	25x3.5 - green	32	green	128(4x32)
1100046975	32x4.4 - white	16	white	64(4x16)
1100052056	32x4.4 - green	16	green	64(4x16)
1100046966	40x5.5 - white	48	white	48(4x12)
1100052057	40x5.5 - green	48	green	48(4x12)
1100046967	50x6.9 - white	28	white	28(4x7)
1100052058	50x6.9 - green	28	green	28(4x7)
1100046968	63x8.6 - white	20	white	20(4x5)
1100052059	63x8.6 - green	20	green	20(4x5)
1100046969	75x10.3 - white	16	white	16(4x4)
1100052060	75x10.3 - green	16	green	16(4x4)
1100046970	90x12.3 - white	12	white	12(4x3)
1100052061	90x12.3 - green	12	green	12(4x3)
1100046971	110x15.1 - white	8	white	8(4x2)
1100052062	110x15.1 - green	8	green	8(4x2)
1100046972	160x21.9 - white	4	white	4(4x1)
1100052076	160x21.9 - green	4	green	4(4x1)



PP-R FITTINGEN

Voordelen



Breed assortiment fittingen



Inserts met zwaluwstaart design



Bochten met lange radius



Muurplaatbochten in U vorm



Samenstelling



**Inzetstukken met
zwaluwstaart design**

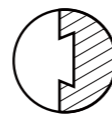

RIIFO PP-R fittingen met draadstukken leveren uitstekende prestaties dankzij het speciale zwaluwstaartontwerp



ZWALUWSTAART DESIGN

De verschillende thermische uitzettingen van de materialen worden opgevangen door het zwaluwstaart design



36 BIJTPUNTEN

Anti-axiale slip tussen het metalen inzetstuk en het plastic.

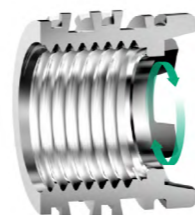

VEILIGHEIDSRING

Anti-over-twist bij het installeren van apparaten met schroefdraad.

Doorverbinder



Artikelnummer	Specificaion	Doos (pcs)	Karton (pcs)
1100041412	20x20	135	1620
1100041413	25x25	60	720
1100041414	32x32	40	480
1100041415	40x40		210
1100041416	50x50		112
1100041417	63x63		64
1100041418	75x75		48
1100041419	90x90		20
1100041420	110x110		12

Reductie



Artikelnummer	Specificaion	Doos (pcs)	Karton (pcs)
1100041421	25x20	90	1080
1100041422	32x20	60	720
1100041423	32x25	50	600
1100041424	40x20		300
1100041425	40x25		300
1100041426	40x32		200
1100041427	50x20		160
1100041428	50x25		160
1100041429	50x32		168
1100041430	50x40		112
1100045009	63x20		81
1100045008	63x25		96
1100041431	63x32		81
1100041432	63x40		98
1100041433	63x50		70
1100041434	75x63		36
1100041435	90x50		28
1100041436	90x63		20
1100041437	90x75		24
1100041438	110x50		18
1100041439	110x63		20
1100041440	110x75		20
1100041441	110x90		12

Doorverbinder in S-vorm



Artikelnummer	Specificaion	Doos (pcs)	Karton (pcs)
1100043460	20x20	30	480
1100043461	25x25	20	300

Brug



Artikelnummer	Specificaion	Doos (pcs)	Karton (pcs)
1100041713	20x20	30	360
1100041939	25x25	24	288
1100043468	32x32	10	120

Lange brug



Artikelnummer	Specificaion	Doos (pcs)	Karton (pcs)
1100044995	20x20(L)(2.5)		165
1100044996	25x25(L)(2.5)		96
1100044997	32x32(L)(2.5)		70

Puntstuk buitendraad



Artikelnummer	Specificaion	Doos (pcs)	Karton (pcs)
1100041923	20x1/2M	40	240
1100043469	20x3/4M	30	180
1100041924	25x1/2M	35	210
1100043470	25x1M	15	90
1100041925	25x3/4M	30	180
1100043471	32x1/2M	30	180
1100041926	32x1M	12	72
1100043472	32x1M	24	144
1100043473	40x11/4M		60
1100043474	50x11/2M		45
1100043475	63x2M		24

Puntstuk binnendraad



Artikelnummer	Specificaion	Doos (pcs)	Karton (pcs)
1100041703	20x1/2F	60	360
1100043476	20x3/4F	40	240
1100041927	25x1/2F	50	300
1100043477	25x1F	16	96
1100041928	25x3/4F	30	180
1100043478	32x1/2F	40	240
1100041929	32x1F	16	96
1100043479	32x3/4F	30	180
1100043480	40x11/4F		80
1100043481	50x11/2F		60
1100043482	63x2F		36

Demonteerbare rechte koppeling



Artikelnummer	Specificaion	Doos (pcs)	Karton (pcs)
1100041510	20x20(H)	20	120
1100041511	25x25(H)	15	90
1100041512	32x32(H)	12	72
1100043507	40x40(H)	9	54
1100043508	75x75(H)		10

Demonteerbare rechte koppeling, buitendraad



Artikelnummer	Specificaion	Doos (pcs)	Karton (pcs)
1100045016	20x1/2M(H)	25	150
1100045017	25x1/2M(H)	20	120
1100045018	25x3/4M(H)	25	150
1100045019	25x1M(H)	20	120
1100045020	32x3/4M(H)	15	90
1100045021	32x1M(H)	12	72
1100045022	40x11/4M(H)		60
1100045023	50x11/2M(H)		45
1100045024	63x2M(H)		18

Rechte koppeling binnendraad, met wartel en vlakke dichting



Artikelnummer	Specificaion	Doos (pcs)	Karton (pcs)
1100045025	20x1/2F(H)	30	180
1100045026	25x1/2F(H)	20	120
1100045027	25x3/4F(H)	20	120
1100045028	32x1F(H)	15	90
1100045029	40x11/4F(H) II		60
1100045030	50x11/2F(H) II		45

Stop



Artikelnummer	Specificaion	Doos (pcs)	Karton (pcs)
1100041442	D20	180	2160
1100041443	D25	150	1800
1100041444	D32	70	840
1100041445	D40		325
1100041446	D50		176
1100041447	D63		90
1100041448	D75		72
1100041449	D90		34
1100041450	D110		24

T stuk



Artikelnummer	Specificaion	Doos (pcs)	Karton (pcs)
1100041472	20x20x20	60	720
1100041473	25x25x25	32	384
1100041474	32x32x32	20	240
1100041475	40x40x40		92
1100041476	50x50x50		54
1100041477	63x63x63		27
1100041478	75x75x75		14
1100041479	90x90x90		10
1100041480	110x110x110		4

T reductie



Artikelnummer	Specificaion	Doos (pcs)	Karton (pcs)
1100041481	25x20x20	50	600
1100041482	25x20x25	40	480
1100041483	32x20x32	20	240
1100041484	32x25x32	20	240
1100041485	40x20x40		120
1100041486	40x25x40		120
1100041487	40x32x40		112
1100041488	50x20x50		88
1100041489	50x25x50		80
1100041490	50x32x50		60
1100041491	50x40x50		60
1100043462	63x20x63		45
1100041492	63x25x63		45
1100041493	63x32x63		36
1100041494	63x40x63		36
1100041495	63x50x63		27
1100041496	75x25x75		33
1100041497	75x32x75		30
1100041498	75x40x75		24
1100041499	75x50x75		20
1100041500	75x63x75		18
1100045012	90x32x90		14
1100041501	90x40x90		12
1100041502	90x50x90		12
1100041503	90x63x90		12
1100041504	90x75x90		12
1100045013	110x25x110		12
1100041505	110x40x110		12
1100041506	110x50x110		10
1100041507	110x63x110		8
1100041508	110x75x110		6
1100041509	110x90x110		4

T met zachte bocht



Artikelnummer	Specificaion	Doos (pcs)	Karton (pcs)
1100043463	20x20x20	20	240
1100043464	25x25x25	15	180

Hoek T



Artikelnummer	Specificaion	Doos (pcs)	Karton (pcs)
1100045000	20x20x20	30	360
1100045001	25x25x25	30	360
1100045002	32x32x32	15	240

T met doorverbinding



Artikelnummer	Specificaion	Doos (pcs)	Karton (pcs)
1100043465	X20x20x20x20	30	360
1100043466	X25x25x25x25	24	288
1100043467	X32x32x32x32	12	144

T buitendraad



Artikelnummer	Specificaion	Doos (pcs)	Karton (pcs)
1100041935	20x1/2Mx20	30	180
1100041936	25x1/2Mx25	24	144
1100041937	25x3/4Mx25	20	120
1100043505	32x1/2Mx32	15	90
1100043506	32x3/4Mx32	15	90
1100041938	32x1Mx32	10	60

T binnendraad



Artikelnummer	Specificaion	Doos (pcs)	Karton (pcs)
1100041698	20x1/2Fx20	36	216
1100041699	25x1/2Fx25	30	180
1100043499	25x1Fx25	12	72
1100041933	25x3/4Fx25	25	150
1100043500	32x1/2Fx32	18	108
1100041934	32x1Fx32	10	60
1100043501	32x3/4Fx32	12	72
1100043502	40x11/4Fx40	36	36
1100043503	50x11/2Fx50	20	20
1100043504	63x2Fx63	18	18

Reductiebocht 90°



Artikelnummer	Specificaion	Doos (pcs)	Karton (pcs)
1100041469	25x20	50	600
1100041470	32x20	32	384
1100041471	32x25	24	288
1100045010	40x32		120
1100045011	50x32		100

Bocht 90°



Specificaion	Doos (pcs)	Karton (pcs)	Karton (pcs)
1100041451	90°20x20	80	960
1100041452	90°25x25	50	600
1100041453	90°32x32	24	288
1100041454	90°40x40		120
1100041455	90°50x50		57
1100041456	90°63x63		24
1100041457	90°75x75		18
1100041458	90°90x90		12
1100041459	90°110x110		6

Bocht 45°



Artikelnummer	Specificaion	Doos (pcs)	Karton (pcs)
1100041460	45°20x20	90	1080
1100041461	45°25x25	60	720
1100041462	45°32x32	30	360
1100041463	45°40x40		120
1100041464	45°50x50		60
1100041465	45°63x63		36
1100041466	45°75x75		24
1100041467	45°90x90		12
1100041468	45°110x110		8

Ruime bocht



Artikelnummer	Specificaion	Doos (pcs)	Karton (pcs)
1100041940	20x20	20	240
1100041941	25x25	15	180
1100041942	32x32	10	120

Bocht buitendraad 90°



Artikelnummer	Specificaion	Doos (pcs)	Karton (pcs)
1100041930	20x1/2M	40	240
1100043483	20x3/4M	25	150
1100041931	25x1/2M	30	180
1100043484	25x1M	12	72
1100041932	25x3/4M	25	150
1100043485	32x1/2M	24	114
1100043487	32x1M	10	60
1100043486	32x3/4M	20	120
1100043488	40x11/4M		36
1100043489	50x11/2M		30
1100043490	63x2M		16

Bocht binnendraad 90°



Artikelnummer	Specificaion	Doos (pcs)	Karton (pcs)
1100041700	20x1/2F	40	240
1100043491	20x3/4F	30	180
1100041701	25x1/2F	35	210
1100043492	25x1F	15	90
1100041702	25x3/4F	30	180
1100043493	32x1/2F	24	144
1100043495	32x1F	12	72
1100043494	32x3/4F	16	96
1100043496	40x11/4F		48
1100043497	50x11/2F		30
1100043498	63x2F		18

Bocht binnendraad 90°, met wartel en vlakke dichting



Artikelnummer	Specificaion	Doos (pcs)	Karton (pcs)
1100045032	20x1/2F(H2)	50	300

Muurplaatbocht binnendraad



Artikelnummer	Specificaion	Doos (pcs)	Karton (pcs)
1100045014	20x1/2F(Z)	35	210
1100045015	25x1/2F(Z)	30	180

Rechte montagebeugel met twee muurplaatbochten



Artikelnummer	Specificaion	Doos (pcs)	Karton (pcs)
1100045045	20x1/2F(100)	6	72
1100045046	25x1/2F(100)	6	72
1100045047	20x1/2F(150)	5	60
1100045048	25x1/2F(150)	4	48
1100045049	20x1/2F(200)	4	48
1100045050	25x1/2F(200)	4	48

Rechte montagebeugel met twee U muurplaatbochten



Artikelnummer	Specificaion	Doos (pcs)	Karton (pcs)
1100034214	20x1/2F(150)	3	36
1100034215	25x1/2F(150)	3	36

MEERLAGENBUIS SYSTEEM VOOR GAS



Het systeem mag alleen worden geïnstalleerd in landen waar een systeemcertificaat voor gastoeepassingen beschikbaar is.

PE-X/AL/PE-X MEERLAGENBUIS VOOR GAS

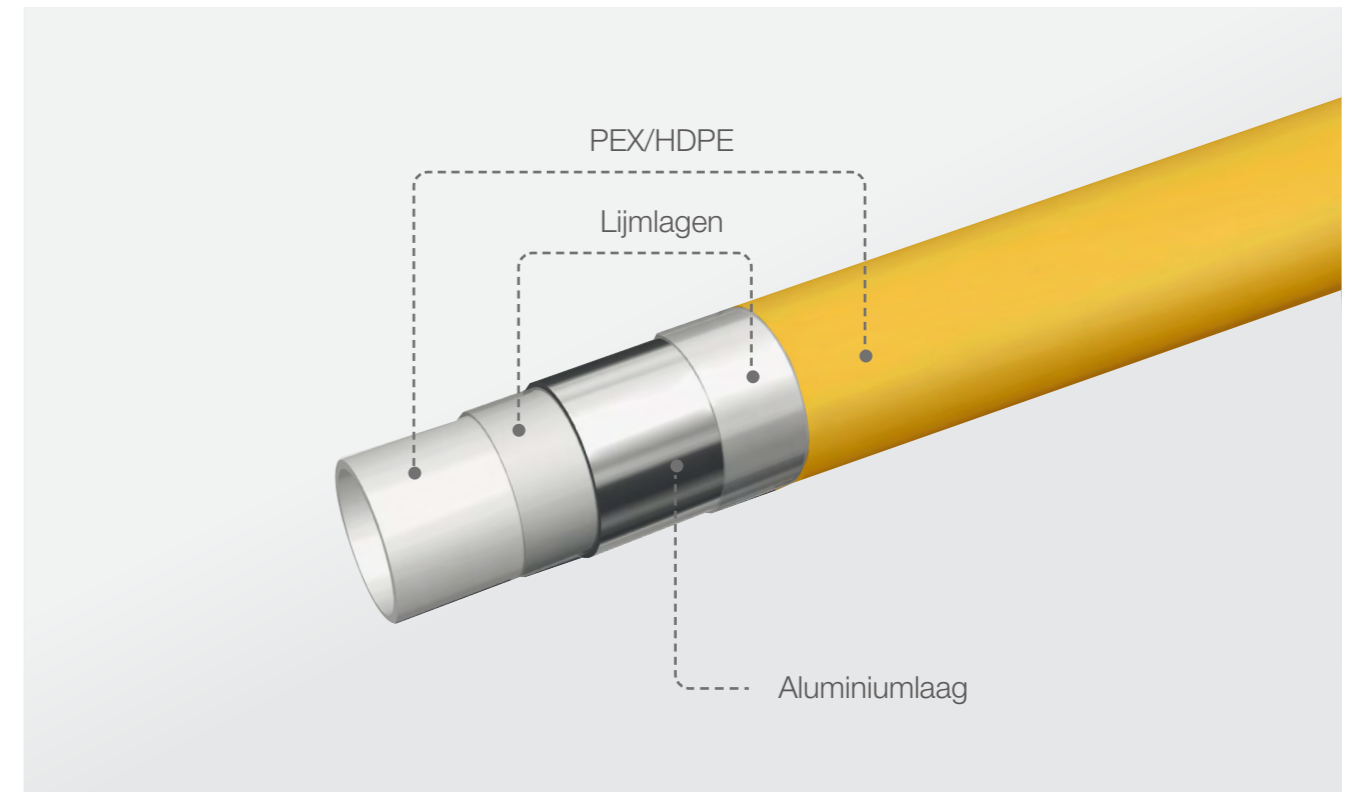

Voordelen



Bestand tegen hoge druk en temperatuur. 10 bar / 95°C.



Lichtgewicht en eenvoudig te installeren



Ondoordringbaar voor zuurstof en licht



Zeer flexibel, maar toch vormstabiel



Met of zonder UV-bescherming



Laag drukverlies door gladde binnenlaag



Low thermal linear expansion



Lage thermische lineaire uitzetting



Corrosiebestendig Hygiënisch

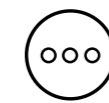

Verkrijgbaar in de kleur geel, zwart en wit

Standaard

- UNE53008.1
- AS 3688
- AS4176.8
- ISO 18225
- ISO17484

Certificaten



SPANJE



AUSTRALIË



NEDERLAND

Meerlagenbuis voor gas (rol)



Artikelnummer	Specificaties	Rol (m)
1100052103	16 x 2	100
1100052104	20 x 2	100
1100052105	26 x 3	50
1100052106	32 x 3	50

Met mantel voor gas (rol)



Artikelnummer	Specificaties	Rol (m)
1100052107	16 x 2 - YEL	50
1100052108	20 x 2 - YEL	50
1100052109	26 x 3 - YEL	50
1100052110	32 x 3 - YEL	50

PERSKOPPELINGEN VOOR GAS

Samenstelling

1 O ring
NBR

3 Lichaam
Messing CW617N

2 Huls
roestvrij staal 304

4 Isolatie:
PE

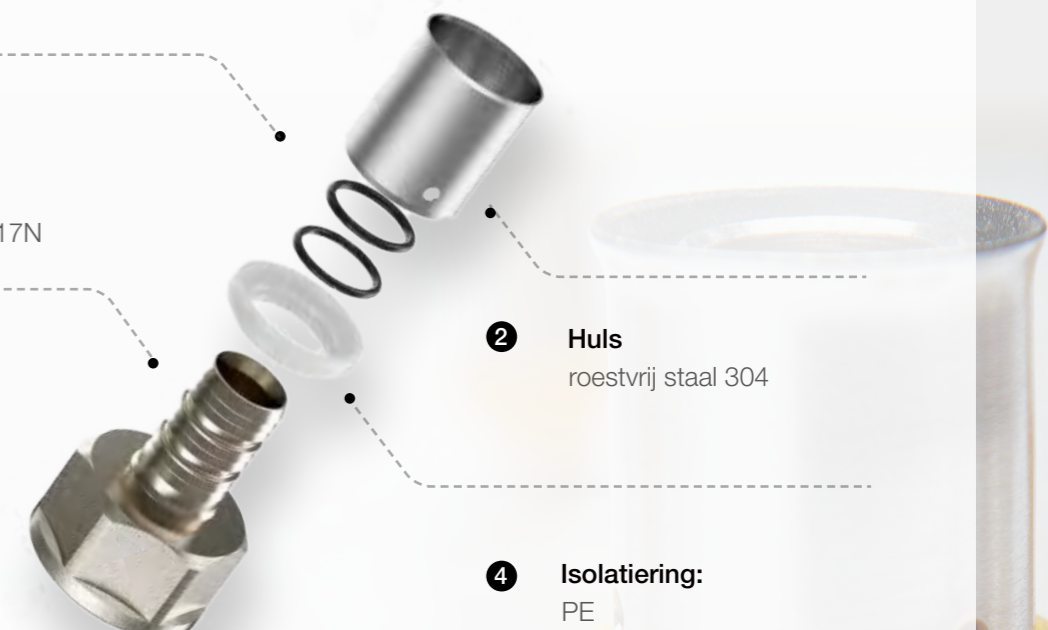

Voordelen



U-persprofiel

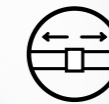

Gemak en veiligheid van installatie



Uitstekende afdichtingsprestaties met dubbele O-ring



Vernikkeling draagt bij aan een goede corrosieweerstand



De spanning en het risico op scheurvorming wordt geëlimineerd door het gloeiproces



Gefreesd door speciale horizontale bewerkingscentra, met een oppervlakte afwerkingsgraad van niet meer dan Ra3,2µm

Doorverbinder



Artikelnummer	Specificaties	Zak (pcs)	Doos (pcs)	Karton (pcs)
1100044906	20x20	7	28	224
1100044907	25x25	5	15	120
1100044908	32x32	1	10	80

Puntstuk buitendraad



Artikelnummer	Specificaties	Zak (pcs)	Doos (pcs)	Karton (pcs)
1100044912	20x1/2M	5	35	280
1100044913	25x3/4M	5	15	120
1100044915	32x1M	1	12	96
1100044914	32x3/4M	4	12	96

Puntstuk binnendraad



Artikelnummer	Specificaties	Zak (pcs)	Doos (pcs)	Karton (pcs)
1100044916	20x1/2F	5	30	240
1100044917	20x3/4F	5	20	160
1100044918	25x3/4F	5	15	120
1100044919	32x3/4F	6	12	96

Bocht 90°



Artikelnummer	Specificaties	Zak (pcs)	Doos (pcs)	Karton (pcs)
1100044920	20x20	6	18	144
1100044921	25x25	1	10	80
1100044922	32x32	1	5	40

Muurplaatbocht binnendraad



Artikelnummer	Specificaties	Zak (pcs)	Doos (pcs)	Karton (pcs)
1100052351	16x1/2F		14	112
1100052352	20x1/2F		12	96

T stuk



Artikelnummer	Specificaties	Zak (pcs)	Doos (pcs)	Karton (pcs)
1100044925	20x20x20	5	15	120
1100044926	25x25x25	1	6	48
1100044927	32x32x32	1	4	32

KRANEN



Kogelkraan met persaansluitingen



Artikelnummer	Specificaties	Zak (pcs)	Doos (pcs)	Karton (pcs)
1100050545	20x1/2M	16	64	
1100050539	25x3/4M	12	48	
1100050540	32x1M	6	24	

Demonteerbare kogelkraan



Artikelnummer	Specificaties	Zak (pcs)	Doos (pcs)	Carton (pc.)
1100042054	20x20	15	90	
1100042055	25x25	10	60	
1100042056	32x32	8	48	
1100042057	40x40	4	24	
1100042058	50x50	4	24	
1100042059	63x63	2	12	

Stopkraan



Artikelnummer	Specificaties	Zak (pcs)	Doos (pcs)	Carton (pc.)
1100041911	20x20	12	72	
1100041912	25x25	12	72	
1100041913	32x32	6	36	
1100041914	40x40	1	32	
1100041915	50x50	1	12	
1100041916	63x63	1	8	

Kogelkraan met mannelijke en vrouwelijke schroefdraadaansluitingen



Artikelnummer	Specificaties	Zak (pcs)	Doos (pcs)	Carton (pc.)
1100048782	16x16			210
1100048783	20x20			120
1100048784	26x26			84

Opbouw PPR kraan



Artikelnummer	Specificaties	Zak (pcs)	Doos (pcs)	Carton (pc.)
1100041917	20x20		1	16
1100041918	25x25		1	16
1100041919	32x32		1	12

Inbouw PP-R kraan met keramische kern



Artikelnummer	Specificaties	Zak (pcs)	Doos (pcs)	Karton (pcs)
1100038627	20x20		1	16
1100038628	25x25		3	16
1100038629	32x32		1	12

Inbouw PP-R kraan met keramische kern



Artikelnummer	Specificaties	Zak (pcs)	Doos (pcs)	Carton (pc.)
1100038697	20x20		1	45
1100038701	25x25		1	45

Stopkraan massastroom



Artikelnummer	Specificaties	Zak (pcs)	Doos (pcs)	Carton (pc.)
1100038691	20x20		6	36
1100038692	25x25		6	36
1100038693	32x32		4	24

PP-R terugslagklep



Artikelnummer	Specificaties	Zak (pcs)	Doos (pcs)	Carton (pc.)
1100038694	20x20		20	120
1100038695	25x25		16	96
1100038696	32x32		8	48

Regelbare kraan



Artikelnummer	Specificaties	Zak (pcs)	Doos (pcs)	Carton (pc.)
1100026922	20x1/2 straight		8	48
1100026923	20x1/2 angled		8	48
1100026924	25x3/4 straight		6	36
1100026925	25x3/4 angled		6	36

TOOLS EN TOEBEHOREN

Buizenschaar



Artikelnummer	Specificaties	Zak (pcs)	Doos (pcs)	Carton (pc.)
1100015650	PC-1232		1	

Buizensnijder



Artikelnummer	Specificaties	Zak (pcs)	Doos (pcs)	Carton (pc.)
1100044112	WC-1275		1	

Kalibreer-en afschuintool



Artikelnummer	Specificaties	Zak (pcs)	Doos (pcs)	Carton (pc.)
1100018271	CCT-162026		1	

Kalibreer- en afschuintool voor montage op handvat of boormachine



Artikelnummer	Specificaties	Zak (pcs)	Doos (pcs)	Carton (pc.)
1100018260	CCT-16		1	
1100018261	CCT-20		1	
1100018263	CCT-32		1	
1100018264	CCT-40		1	
1100018265	CCT-50		1	
1100018266	CCT-63		1	
1100018267	CCT-75		1	

Binnenbuigveer



Artikelnummer	Specificaties	Zak (pcs)	Doos (pcs)	Carton (pc.)
1100033464	IBS-16			
1100033487	IBS-20			
1100033490	IBS-32			

Buitenbuigveer



Artikelnummer	Specificaties	Zak (pcs)	Doos (pcs)	Carton (pc.)
1100033492	EBS-16			
1100033494	EBS-20			
1100033496	EBS-26			
1100033497	EBS-32			

Manuele perstang



Artikelnummer	Specificaties	Zak (pcs)	Doos (pcs)	Carton (pc.)
1100015725	MPM-TH1432		1	

Wisselbekken TH profiel voor manuele perstang



Artikelnummer	Specificaties	Zak (pcs)	Doos (pcs)	Carton (pc.)
1100033464	IBS-16			
1100033487	IBS-20			
1100033490	IBS-32			

Mini-Press 22V 22kN persmachine met batterij, lader en TH-persbekken diameter 16, 20 en 26



Artikelnummer	Specificaties	Zak (pcs)	Doos (pcs)	Carton (pc.)
1100052529	PMINI-22V- 22kN- set1		1	

Persbekken TH profiel voor Mini-Press persmachine



Artikelnummer	Specificaties	Zak (pcs)	Doos (pcs)	Carton (pc.)
1100052530	TH16 Mini		1	
1100052531	TH20 Mini		1	
1100052532	TH26 Mini		1	
1100052533	TH32 Mini		1	

Persbekken U profiel voor Mini-Press persmachine



Artikelnummer	Specificaties	Zak (pcs)	Doos (pcs)	Carton (pc.)
1100052534	U16 Mini		1	
1100052535	U20 Mini		1	
1100052536	U26 Mini		1	
1100052537	U32 Mini		1	

Akku-Press Elektrohydraulische persmachine 32 kN met 22V batterij



Artikelnummer	Specificaties	Zak (pcs)	Doos (pcs)	Carton (pc.)
1100052538	PM-22V-32 kN		1	

Adapter voor netaansluiting Akku-Press persmachine



Artikelnummer	Specificaties	Zak (pcs)	Doos (pcs)	Carton (pc.)
1100052539	PM-ADAPTER			

Persbekken TH profiel voor Akku-Press persmachine



Artikelnummer	Specificaties	Zak (pcs)	Doos (pcs)	Carton (pc.)
1100052540	TH16		1	
1100052541	TH20		1	
1100052542	TH26		1	
1100052543	TH32		1	
1100052544	TH40		1	
1100052545	TH50		1	
1100052546	TH63		1	
1100052547	TH75		1	

Persbekken U profiel voor Akku-Press persmachine



Artikelnummer	Specificaties	Zak (pcs)	Doos (pcs)	Carton (pc.)
1100052548	U16		1	
1100052549	U20		1	
1100052550	U26		1	
1100052551	U32		1	
1100052552	U40		1	
1100052553	U50		1	
1100052554	U63		1	
1100052555	U75		1	

Hot melting machine



Artikelnummer	Specificaties	Zak (pcs)	Doos (pcs)	Carton (pc.)
1100022719	HFM-PPR		1	

Hot-melt matrijskop



Artikelnummer	Specificaties	Zak (pcs)	Doos (pcs)	Carton (pc.)
1100042022	MH-PPR-20		1	
1100042023	MH-PPR-25		1	
1100042024	MH-PPR-32		1	
1100042025	MH-PPR-40		1	
1100042026	MH-PPR-50		1	
1100042027	MH-PPR-63		1	
1100042028	MH-PPR-75		1	
1100042029	MH-PPR-90		1	

Testplug voor buis



Artikelnummer	Specificaties	Zak (pcs)	Doos (pcs)	Carton (pc.)
1100052567	16	10		
1100052568	20	10		
1100052569	26	10		

INSTALLATIE

Knelkoppeling

Stap1:

Snijd de buis verticaal af, in een hoek van 90°.

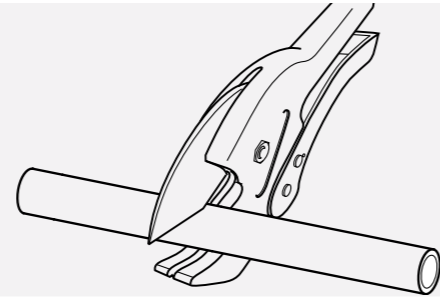

Stap2:

Gebruik kalibreergereedschap om de buis rond te maken en af te schuinen.

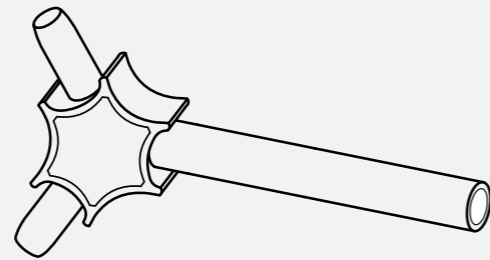

Stap3:

Plaats de moer en de knelring over de buis.

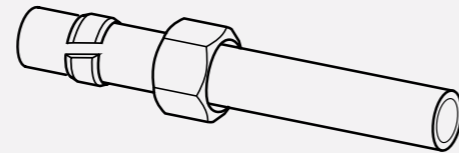

Stap4:

Steek de buis in de koppeling en zorg ervoor dat de buis volledig is ingebracht. Zorg ervoor dat u de O-ringen niet beschadigt tijdens dit montageproces.

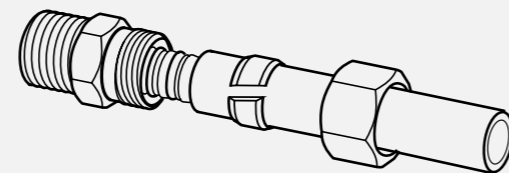

Stap5:

Draai de moer vast met uw vinger.

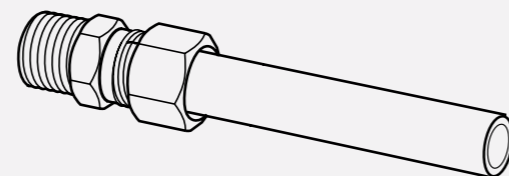

Stap6:

Draai de moer vast met een sleutel.

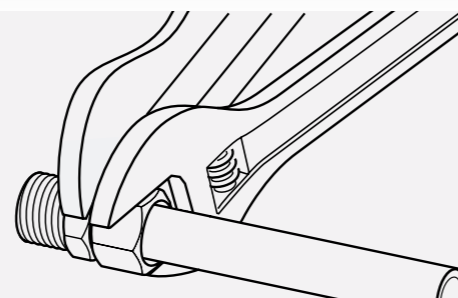

Perskoppeling

Stap1:

Snijd de buis verticaal af, in een hoek van 90°.

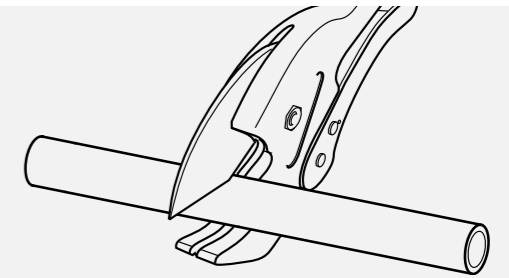

Stap2:

Gebruik kalibreergereedschap om de buis rond te maken en af te schuinen.

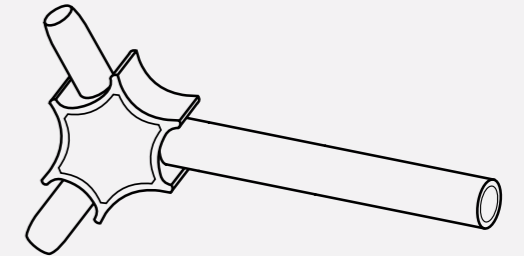

Stap3:

Kies de juiste maat fitting voor de buis. Duw de buis in de fitting, tot aan de schouder. Controleer de insteekdiepte via de inspectievensters in de pershuls om er zeker van te zijn dat de buis volledig is ingebracht.

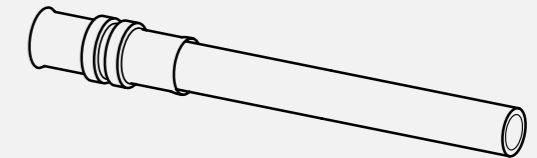

Stap4:

Open het persgereedschap en plaats het gereedschap recht op de roestvrijstalen pershuls.

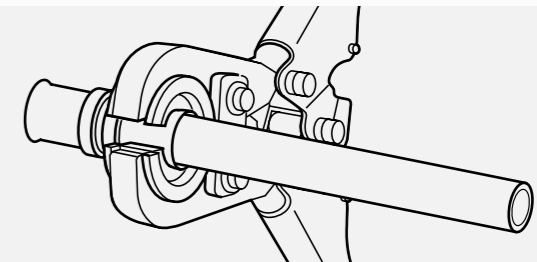

Stap5:

De U-profiel persbek dient zijdelings tegen de kunststof isolatie te worden geplaatst. In het geval van een TH-profiel persbek, dient de kunststof isolatie of -afstandsring in de groef van de TH-persbek geplaatst te worden.

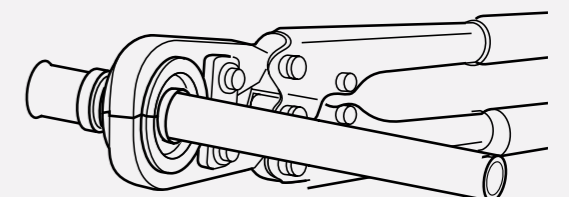

Stap6:

Handgereedschap: zorg ervoor dat de bek volledig gesloten is door de handgrepen samen te drukken. De hendels worden vergrendeld. Open de hendels en verwijder het gereedschap. De verbinding is gemaakt. Elektro hydraulisch gereedschap: druk op de activeringsknop op de machine en wacht tot de perscyclus is voltooid. Open de persbek. De verbinding is gemaakt.

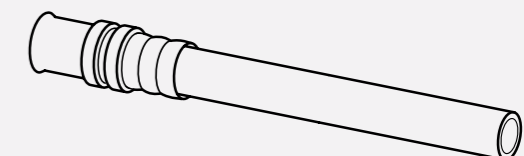

INSTALLATIE

MERK OP!

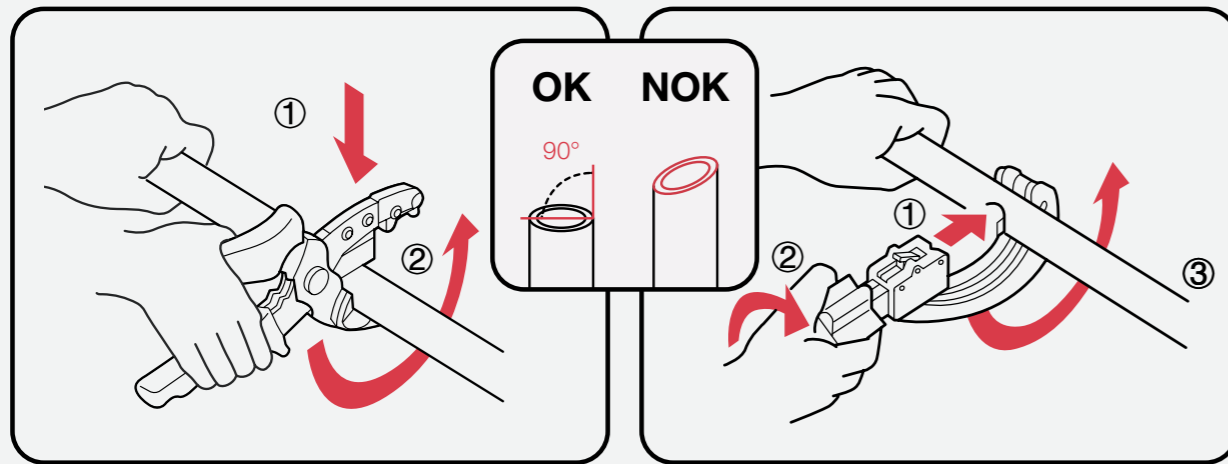

WAARSCHUWING!

Bij een verkeerde bediening kan er gevaar voor letsel ontstaan.

Gebruik het gereedschap alleen zoals beschreven in de gebruiksaanwijzing.

OPMERKING!

Verkeerd afsnijden of afknippen veroorzaakt lekkages.

- Zorg ervoor dat het uiteinde van de buis verticaal is afgesneden.

- Zorg ervoor dat het uiteinde van de buis rond is. Gebruik altijd kalibreer- en afschuinigereedschap na het doorknippen.

GARANTIE

RIIFO biedt 25 jaar systeemgarantie. Deze garantie wordt ondersteund door een internationale verzekeringsmaatschappij. Gelieve contact op te nemen met ons bedrijf voor gedetailleerde informatie over onze productgarantie.

